

# Cat 6A

Interactive Reference Guide

Europe



## Understanding Cat 6A

Cat 6A projects require proper design, planning, products, and installation practices. Use this guide to gain a better understanding of these requirements to help you efficiently plan, bid, and install a Cat 6A structured cabling system for networks up to 10 gigabit Ethernet. This guide will also cover the general areas and applications where Cat 6A may be deployed, and give you an overview of Leviton's Cat 6A system connectivity.



Cat 6A

## Where is Cat 6A used?

Category 6A cabling systems have come a long way since the original “augmented Category 6” standard was first introduced in 2008. Today, Cat 6A is a popular specification for data center and other enterprise applications. The move to Cat 6A has been driven by several factors, including support for 10G networks, long-term planning for workstation areas, Power over Ethernet (PoE) applications, audiovisual signals, and new wireless access points.



### Data Centers

Many data center managers looking to control costs are choosing Cat 6A twisted pair copper for 10 Gb/s applications, since it is the most cost-effective option for access layer networking. In fact, the cost of 10GBASE-T channels is at least 30% lower than alternative SFP+ channels.



### Wireless Applications

More businesses are updating their wireless networks with 802.11ac access points, capable of delivering up to 6.9 Gb/s. Future standard 802.11ax will support speeds up to 10 Gb/s. Businesses won't see the true benefits of these higher speeds without the right cabling infrastructure; that's why industry standards recommend Cat 6A for horizontal cabling to these wireless access points.

## Where is Cat 6A used?



### Power over Ethernet (PoE)

PoE is seeing explosive growth rates, boosted by new applications and standards that expand support to more devices. Higher current PoE brings important cabling and connectivity considerations while ensuring utmost performance in the network, and for this reason Cat 6A is recommended for all new installations.

### 10GBASE-T Networks

Data centers, businesses, government agencies, hospitals, and schools are all looking to 10 Gb/s networks to meet today's data demand. Since its introduction in 2008, 10GBASE-T has become widely adopted around the world. The standard defines 10 Gb/s over twisted-pair up to 100 meters, with Cat 6A as the required cabling.



### HDBaseT Networks

HDBaseT™ is a key technology that enables audio visual signal extension over category cabling to high definition displays and projectors. It extends HDMI® video and audio, 100BaseT Ethernet, control, and power up to 100 meters on a single category-rated twisted-pair cable. The HDBaseT Alliance specifies Cat 5e, Cat 6 UTP, and Cat 6A UTP cabling as supported media types. But these category ratings will deliver varying performance results, with Cat 6A more capable of supporting higher bandwidth signals such as 4K.

## Standards

Cat 6A requirements are addressed in standards from multiple organizations. Regardless of the standard, all Cat 6A cabling will provide 10 Gb/s data rates, operate at a maximum frequency of 500 MHz, and have a maximum distance of 100 meters.

## ISO/IEC (International Standards Organization)

**Standard:** ISO/IEC 11801-1 (Information Technology — Generic Cabling for Customer Premises; Class E<sub>A</sub> Specification)

**Defines:** Class E<sub>A</sub> cabling and component performance requirements for customer premises. ISO equivalent of Cat 6A

### Power over Ethernet:

The ISO/IEC 11801-6 Distributed Building Services standard raises cabling requirements to Category 6A to better support IEEE 802.3bt four-pair PoE



## IEEE (Institute of Electrical and Electronics Engineers)

**Standard:** IEEE 802.3 an

**Defines:** Channel performance for 10GBASE-T Ethernet over balanced twisted-pair cabling systems

**Standard:** IEEE 1911.3

**Defines:** Protocol for communicating 5Play™ over a single long-distance Local Area Network (LAN) cable.



## CENELEC (European Committee for Electromechanical Standardization)

**Standard:** EN50173 (Information Technology — Generic Cabling Systems)

**Defines:** Class E<sub>A</sub> cabling and component performance requirements. Matches ISO/IEC 11801-1.



## TIA (Telecommunications Industry Association)

**Telecommunications:** ANSI/TIA-568.2-D (replaces 568-C.2)

**Defines:** Performance requirements for Cat 6A channels, permanent links, and components

### Data Center:

ANSI/TIA-942-B Telecommunications Infrastructure Standards for Data Centers specifies the minimum requirements for telecommunications infrastructure of data centers and computer rooms, including single-tenant enterprise data centers and multi-tenant Internet hosting data centers.

Note: Cat 6A is recommended for horizontal cable in data centers using 100 ohm balanced twisted pair.

### Health Care Facilities:

ANSI/TIA-1179-A Healthcare Facility Telecommunications Infrastructure Standard. Category 6A is recommended for new installations (for both backbone and horizontal copper cabling).

### Power over Ethernet:

TIA TSB-184-A Guidelines for Supporting Power Delivery Over Balanced Twisted-Pair Cabling raises requirements to Category 6A cabling to better support IEEE 802.3bt four-pair PoE.

### Wireless Access Points:

TSB-162-A Telecommunications Cabling Guidelines for Wireless Access Points recommends Cat 6A for horizontal cabling to WAPs in new installations.









## Network Migration

Cat 6A is backwards compatible with Cat 6 and 5e, allowing it to support gigabit Ethernet and provide a seamless migration path to 10 gigabit bandwidth in the future (10GBASE-T). Using Cat 6A in new installations prevents the need to recable when upgrading to 10 Gb/s, avoiding possible network disruption and additional project costs in the future. End users and building owners who are planning for network upgrades or new construction in the near future should consider Cat 6A as a way to extend the expected life of their cabling systems. EN 50173 and ISO 11801 define 2.5GBASE-T and 5GBASE-T as class E<sub>A</sub> applications so they require Class E<sub>A</sub> channels using 6A components.

### Twisted-Pair Migration Roadmap

	1G to 2.5G		2.5G to 5G	5G to 10G	10G to 25G or 40G	
	1G	2.5G	5G	10G	25G	40G
Category	5e / 6	5e / 6	5e / 6	6A	8	8
Max. Bandwidth	100 / 250MHz	100 / 250MHz	100 / 250MHz	500MHz	1250MHz	2000MHz
Max. Application Data Rate	1000BASE-T	2.5GBASE-T	5GBASE-T	10GBASE-T	25GBASE-T	40GBASE-T
Max. Reach	100m	100m	100m	100m	30m	30m
Cable Construction	Unshielded or Shielded	Unshielded or Shielded	Unshielded or Shielded	Unshielded or Shielded	Shielded	Shielded
Date Created	1999	2016	2016	2006	2016	2016

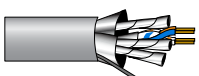
## Copper Cable Terms and Types

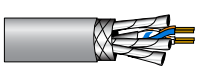
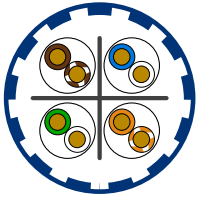
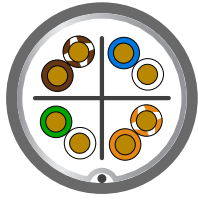
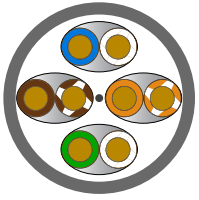
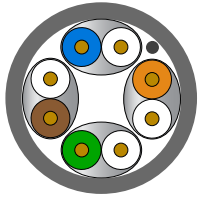
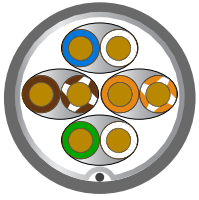
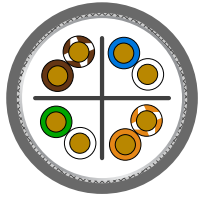
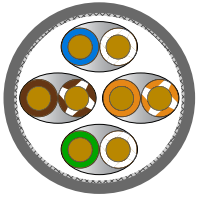
								
	U / UTP	F / UTP	U / FTP		F / FTP	SF / UTP	S / FTP	
Physical Description	Cable	Unshielded	Foil shielded with drain wire	Unshielded	Unshielded zone cable	Foil shielded with drain wire	Foil and braid shielded	Braid shielded
	Pairs	Unshielded	Unshielded	Foil shielded	Foil shielded	Foil shielded	Unshielded	Foil shielded
Cross Section								
Typical Size	7.2 - 8.8 mm (0.283 - 0.346 in)	6.8 - 7.5 mm (0.268 - 0.30 in)	6.7 - 7.6 mm (0.264 - 0.299 in)	5.6 - 5.7 mm (0.220 - 0.224 in)	7.0 - 7.5 mm (0.276 - 0.295 in)	7.4 - 8.3 mm (0.29 - 0.325 in)	7.0 - 7.6 mm (0.276 - 0.299 in)	

## Installation



## Installation

## Routing and Handling



## Routing and Handling

Cat 6A cables are larger and heavier than Cat 6 and earlier cables, and they require modifications to older cable routing and handling techniques.

The following tips will help ensure a smooth installation.



### Cable Reels

Most Cat 6A cable will come on reels instead of in pull boxes and will require racks/carts that can support their larger size.

### Bundling

Use VELCRO® Brand fasteners to secure all cable bundles. Hook and loop fasteners won't crush or damage cables like tie wraps can, and are reusable for moves, adds, and changes. Maximum of 24 cables per bundle of cable.



### Cable Pulling

The maximum pulling tension for a four-pair balanced twisted-pair cable must not exceed 10 kg (98N). Exceeding this tension will result in transmission degradation and may affect the system's ability to pass certification testing.



DO



DON'T

## Routing and Handling

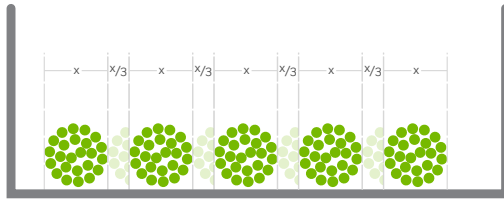

### Placement

Cat 6A cable may be placed in the same tray with Cat 6, 5e, and other category-rated cables should be bundled separately (up to 24 cables in accordance with EN50174-2). In addition, Leviton warrants its product performance regardless of whether strict combing or randomizing dressing methods are used. To reduce the heating within multiple rows of bundles of balanced cables, the bundles should be separated by vertical “chimneys” allowing each bundle to cool by convection. However, a “chimney” width of  $0,3 \times$  bundle diameter only provides limited mitigation and the temperature rise in a bundle should be assumed to be twice that of a single, isolated, bundle in the applicable installation condition.

Follow IEC code for separating power and data cables.

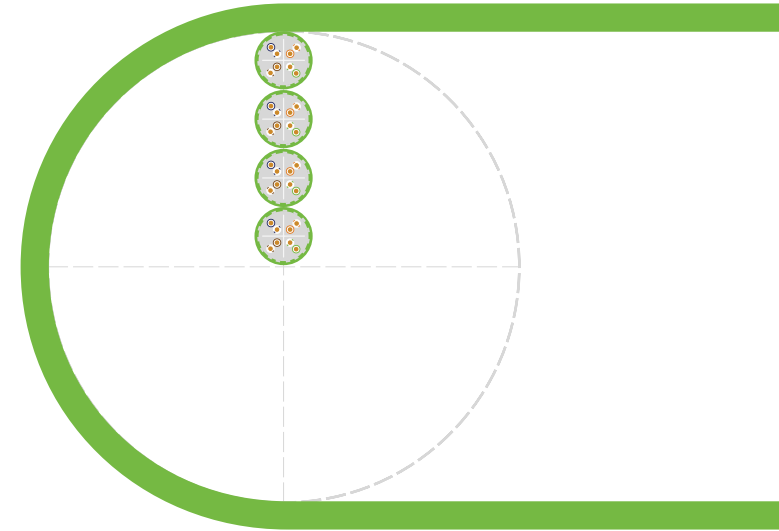

### Bend Radius

To maintain Cat 6A performance, minimum bend radius should be  $4 \times$  OD for UTP and shielded cable. This radius is significantly larger than Cat 6 and 5e. Plan carefully to ensure there is sufficient space throughout cable runs to maintain proper bend radius.

## Routing and Handling



### Slack Loops

ISO/IEC recommends storing a minimum of 3 meters of extra cable in the telecom room and 30-45 centimeters above work area installations for re-terminations and to accommodate moves, adds, and changes. Cable slack in bundled or excessive loops has been shown to degrade cable performance and is associated with return loss failures. Plan carefully to ensure there is sufficient space and support for Cat 6A cable slack. Be sure to check with local guidelines for requirements regarding cable slack loops.

### Pulling Lubricants

To maintain Cat 6A performance, choose spray or wipe lubricants specifically designed for data communications cables. Using other lubricants can degrade performance; the majority of insertion loss failures have been traced back to the use of general purpose lubricants.

## Pathways and Spaces

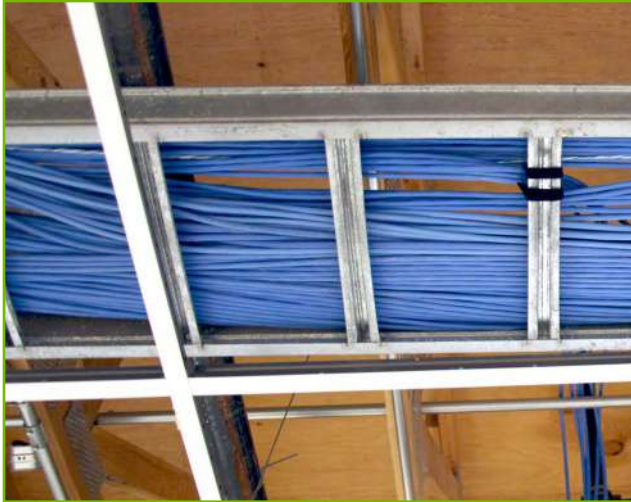



## Pathways and Spaces





### Cable Tray Fill

EN50174-2 recommends 40% fill ratio at initial installation and up to 50% with future additions. If a single cable tray will also carry power cables, a physical barrier is required to comply with IEC. Finally, ensure tray support spacing is sufficient to prevent excessive sagging. Consider solid bottom tray for higher density applications.

Note: A tray at 40% fill ratio looks 80% full. A tray at 50% fill ratio looks completely full. Cable trays should be loaded no more than 150 mm deep.

### Conduit Fill

A maximum conduit fill ratio of 40% is recommended to accommodate cable bundle bend radius requirements.

EXAMPLE CABLE CAPACITY FOR TRAYS AND CONDUIT										
	CAT 5E		CAT 6		CAT 6A		CAT 6A		CAT 6A	
										
	UTP		UTP		UTP		Zone		Shielded	
Average OD	4.85 mm		5.75 mm		7.9 mm		5.7 mm		7.1 mm	
Cable Tray	40%	50%	40%	50%	40%	50%	40%	50%	40%	50%
60 x 150 mm	194	243	138	173	73	91	141	176	90	113
60 x 300 mm	388	486	276	346	146	182	282	352	180	226
60 x 600 mm	776	972	552	692	292	364	564	707	360	452
Conduit	40%		40%		40%		40%		40%	
16 mm	4		3		1*		3		1*	
19 mm	6		4		1*		4		2*	
25 mm	10		7		4		7		4	
32 mm	17		12		6		12		8	

\* Conduit Fill Ratio: 1 cable = 53% maximum, 2 cables = 31%, 3 or more = 40%

## Pathways and Spaces

### Cable Tray Sizing Example

To determine the proper tray size based on an initial 40% fill ratio, use the following calculation (example shown is for 100 cables with outer diameter of 7.1 mm):

1. Determine cable diameter and total number of cables	<b>7.1 mm diameter each 100 cables total</b>
2. Square the cable diameter	<b>7.1 x 7.1 = 50.41</b>
3. Multiply result by number of cables	<b>50.41 x 100 = 5041</b>
4. Multiply result by 0.785 to factor for cable roundness <small>This result is the total cross-sectional area of your cables</small>	<b>5041 x 0.785 = 3957 mm<sup>2</sup></b>
5. Multiply result by 2.5 to obtain pathway size at 40% fill ratio	<b>3957 x 2.5 = 9892.5 mm<sup>2</sup></b>

At 40% fill ratio, a tray with minimum cross-sectional area of 9892.5 mm<sup>2</sup> is required, so a standard 60 x 200 mm (12000 mm<sup>2</sup>) tray would be adequate.

Note: For finding conduit size at 40% fill ratio, the same formula may be used.

$$\text{Cable OD}^2 \times \text{No. of cables} = y$$

$$y \times 0.785 = z$$

$$z \times 2.5 = \text{Pathway size at 40\% fill ratio}$$

## Pathways and Spaces

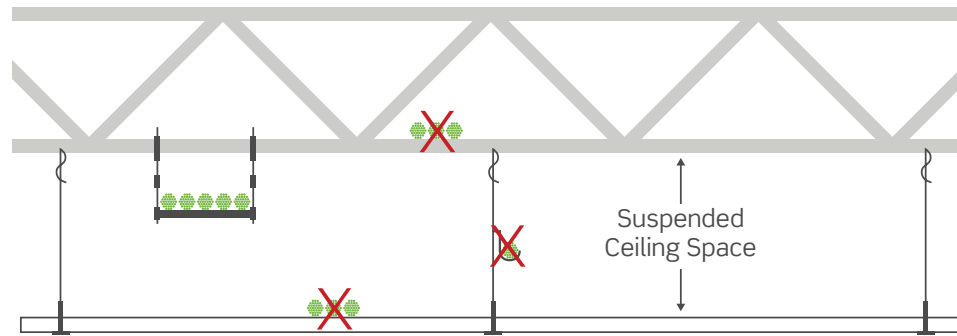

## Structural and Cable Supports

- Stronger anchors and threaded rods are needed to support heavier Cat 6A cable
- Limit bundles to 24 cables (in accordance with EN 50174-2) to prevent damage to cables on the bottom
- Do not exceed cable support manufacturer's recommended capacity
- Space cable supports randomly between 0.9 and 1.2 meters (3 - 4 feet) apart to prevent system degradation due to sagging
- Do not use ceiling support wires or other ceiling components to support communications infrastructure

## Firestopping

Cat 6A cables may require larger firewall penetrations. Always follow applicable local regulations. Within the European Union, the Construction Products Regulations (CPR) defines multiple grades or EuroClasses of cable for indoor installations (Eca, Dca, Cca, and B2ca) based on their reaction to fire. It is important to check your local country regulations to verify the required EuroClass for your specific installation, taking into account any specific EuroClass requirement for fire escapes and other areas within the building that may have a specific EuroClass designation. Leviton has both shielded and unshielded Cat 6A cables available in EuroClass ratings Eca through B2ca.

## Pathways and Spaces

### Consolidation Points

Industry standards allow an optional consolidation point (CP) within a permanent link. Leviton offers Cat 6A consolidation point modules with mounting brackets for secure fixing under floors, on walls, and other areas where consolidation points are found.

Another CP option is to use a patch panel and plug-jack cable assembly. With this option, only an interconnect (one connection) may be used in a patch panel CP application. A cross-connect (two connections with a patch cord) may *not* be used.

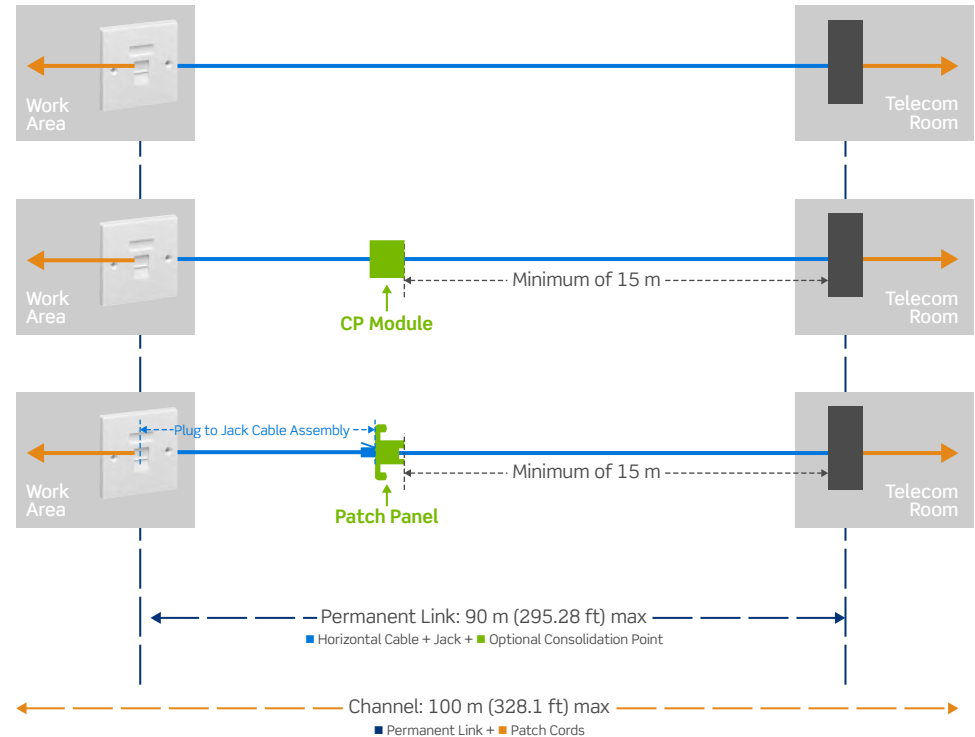

## Telecommunications Rooms

Organising cable runs at racks and cabinets is essential to a well-managed network. Larger, heavier Cat 6A cables may require special planning and equipment for a successful installation. Select the best patch panels, cable management, and patch cords or trunks for your application to speed installation and simplify ongoing management.



## Telecommunications Rooms



### Rear of Rack (cables)

Whether routing cables from above or below, distribute bundles symmetrically to feed into each panel from left and right. This will balance the cable bundles, allow easier access to connections, and reduce congestion at the rear of the panels. Leviton rear cable managers, Versi-Duct® vertical and horizontal finger duct (front/rear versions), and VELCRO® Brand fasteners all support Cat 6A cable at the rear of racks and cabinets.

### TECH TIP: Routing and Patching Cables with One Rear Cable Manager

Follow the suggestions below for managing and dressing Cat 6A cables using a single rear cable management bar with a 2RU 48-port flat patch panel.

1. Split the cable bundle before routing it to the rack; jacks that will terminate to the right side of the panel should route down the right side of the rack. Jacks that will terminate on the left side of the panel route down the left side of the rack. (For angled panels: Jacks on the left will route to the right side and jacks on the right will route to the left, crossing over each other.)
2. Start with the bottom row of patch panel ports, and seat the jacks of the first six terminated cables into the first six ports.
3. Attach the bundle of six cables to the bottom of the cable management bar with VELCRO® Brand fasteners, and dress cables into the vertical cable manager on the right.
4. Install and dress the next group of six in a similar fashion, taking them again to the right side of the vertical cable manager.
5. Move to the left and install and dress the leftmost group of six cables first, then the final group of six on the bottom row of the patch panel.
6. Next, route terminated cables to the top row of patch panel ports.
7. Install the first six on the right and route the cables over the top of the cable management bar.
8. Attach this bundle in place to the top of the cable management bar with VELCRO® Brand fasteners, and dress it into the vertical cable manager.
9. Do the same with the next three top bundles.

## Telecommunications Rooms



### Front of Rack (cords)

Symmetrically dress cords and route into cable management. Leviton's Cat 6A cords have been independently- and field-tested to ensure 10G performance, whether they are strictly combed or randomized in cable managers. Our horizontal ring-type cable managers as well as horizontal and vertical Versi-Duct® products help manage patch cords at the front of the rack. To reduce cord bundle sizes and save rack space, consider using angled patch panels with Versi-Duct vertical managers, as the angled design eliminates the need for horizontal managers.

### Bend Radius

To maintain Cat 6A performance, minimum bend radius should be 4x OD for UTP and shielded cable. This radius is significantly larger than Cat 6 and 5e. For example, Cat 6 cables at 4x OD is 23 mm (0.9"), whereas Cat 6A is 31 mm (1.21"). Plan carefully to ensure there is sufficient space throughout cable runs to maintain proper bend radius.

## Telecommunications Rooms



### High-Density Patching

Many IT managers face physical space constraints, with limited room for additional network infrastructure. High-density patch panels are an efficient way to increase copper port density in racks. While standard patch panels offer 24 ports in one rack unit, high-density panels can double that amount with 48 ports per rack unit. However, one should factor in Cat 6A cable size when considering high-density panels, as too many panels in a rack or cabinet may create unwanted congestion.

Angled panel designs can also consolidate rack space, as they allow for proper cable bend radius without needing horizontal cable managers typically found above and below traditional flat panels in the rack.

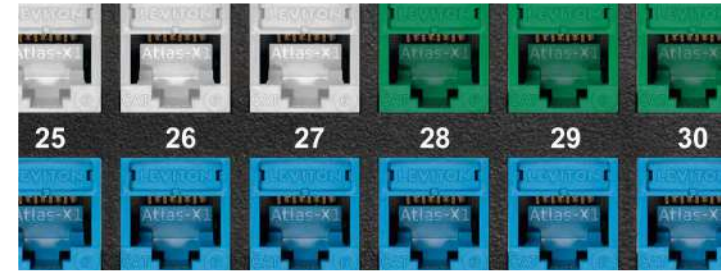

### TECH TIP: Color Coding

Enhance telecom room and data center organization by color-coding jacks and patch cords. Choose from several schemes, depending on application and system management priorities:

- A/B switch fabric for data center redundancy
- Connectivity types such as WAN/corporate data, LAN, engineering networks, voice, and more
- Campus location
- Company colors



## Telecommunications Rooms — Leviton Solutions



## Work Area

Connectivity in the work area requires a finished look, ease of maintenance, and performance, all while meeting installation codes and guidelines. Simplify work area connectivity planning, design, and installation with the following tips.



## Work Area — Cabling



### In-Wall Applications

Cat 6A cables require additional depth behind faceplates and at all directional changes to maintain proper bend radius. Before installation, verify that the design allows sufficient depth throughout the cable pathway.



### Drop Ceiling Applications

Cable infrastructure must be independently suspended by components designed for this purpose, separate from all other building systems. Do not use ductwork, piping, earthquake bracing, or the drop ceiling grid to suspend cable or cabling support infrastructure.

## Work Area — Cabling

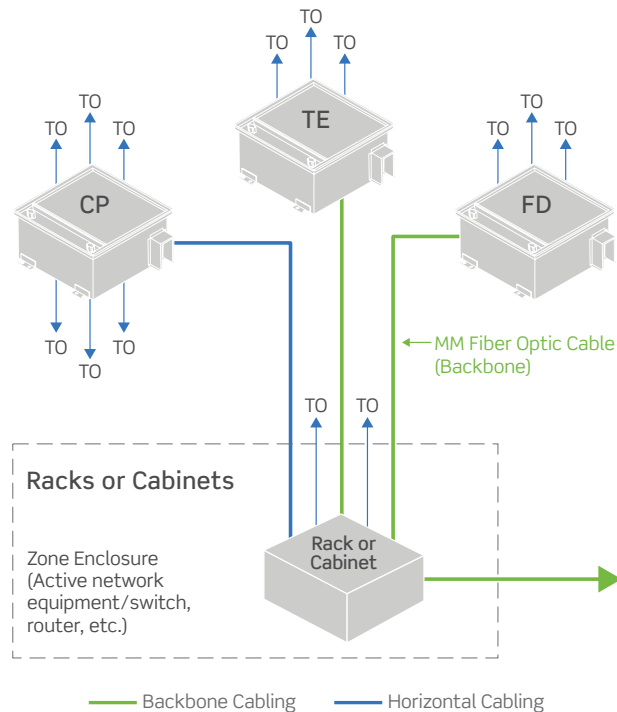

### Consolidation Points and Zone Cabling

In a zone cabling design, cables are routed from the telecommunications room (TR) or floor distributor (FD) to appropriately placed zone enclosures or telecommunications enclosures (TE). Cabling is then run from the zone enclosure to each telecom outlet (TO). This kind of cabling design is ideal for open office architecture. When work areas are modified, cabling need only be reconfigured back to the consolidation point, rather than all the way to the telecom room.

Zone cabling benefits include:

- Maximum infrastructure flexibility
- Improved network performance
- Simplified moves, adds, and changes
- Reduced use of floor space
- Reduced cost of ownership

## Work Area — Workstations

### Junction Boxes and Mud Rings

Verify that the connectivity design specifies the proper junction box size before drywall is installed. Consider an oversized junction box to accommodate Cat 6A cabling and bend radius requirements or utilize box eliminators.



### Surface-Mount Boxes

To maintain proper bend radius, consider exiting cable from modular furniture pathways into a surface-mount box instead of directly to a faceplate. Leviton's extended depth four-port surface-mount box works with most modular furniture and is an excellent solution for larger Cat 6A bend radius requirements.



### TECH TIP: Modular Furniture Installations

Cubicle furniture and walls often have restricted wireways. Determine cable capacity before finalising specifications to verify there is adequate space for cables and bend radius requirements. Consider mocking up a cubicle. Most cubicle installations use surface mount boxes, which help offset the space restrictions of narrow cubicle walls.

Work Area — Leviton Solutions



## Applications



## Applications

## Data Centers

Data centers are one of the most critical parts of any data network and thus require the highest levels of performance and reliability. Cabling for data centers differs from horizontal installations in several ways: typical distances, network function, pathways, and spaces. Cat 6A cabling may affect requirements for all of these, but especially pathways and spaces. Careful planning and proper specifications will help ensure a successful installation.

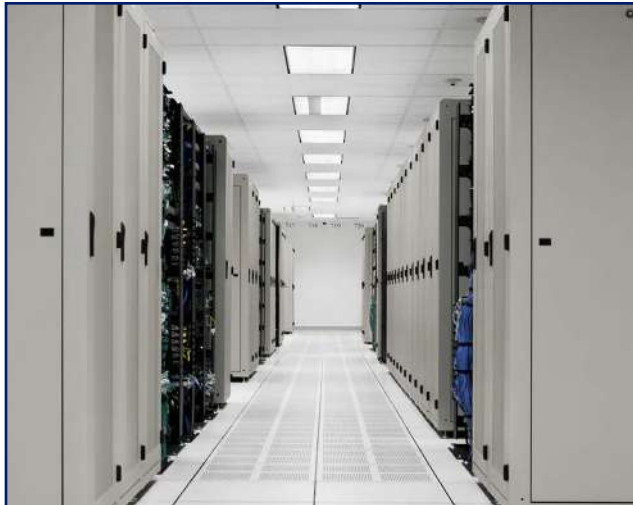



## Data Centers — Pathways and Spaces

In recent years, data center switches have been introduced that support 10GBASE-T at lower costs and higher densities, such as the Cisco Nexus 9500 Series and Arista 7300 Series switches. These switch manufacturers and others are promoting “flatter” network architectures that remove some of the north-to-south traffic from switch to server, and replace it with east-to-west, server-to-server designs.

As these new switches and architectures become widely used, it’s important to understand how higher densities will affect cabling pathways, as cabinet and cable tray space may become an issue. Cat 6A cabling used to support the 10GBASE-T server connections has a significant impact on the physical support infrastructure needed to deploy it.

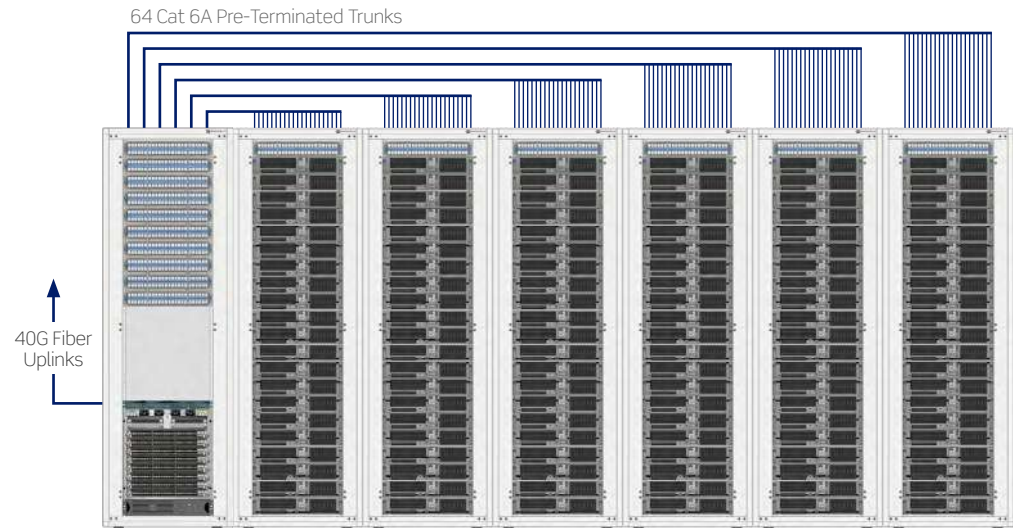

Higher density example: 8-Cabinet Row with Cisco Nexus 9508 Switch

## Data Centers — Raised Floor vs. Overhead Cable Runs



There are three typical data center Cat 6A cable run configurations: power and data cabling both under a raised floor, both overhead, or power below and data overhead. The chosen configuration will affect other data center design elements:

- If power and communications cable are both overhead, cable trays must be properly sized, separated, and configured to support 6A cables and accommodate power runs.
- If both are underfloor, pedestals must be higher to accommodate larger 6A cables, room for expansion, segregation from power runs, and proper airflow.

### INSTALLATION BEST PRACTICES

Pathways should be sized for 40% initial fill ratio, which allows space for up to 50% fill with future additions. Pathways should be no more than 15 cm (150 mm) deep; larger deployments may use multiple trays or pathways to support cabling requirements. See [page 18](#) for cable tray sizing in pathways.

Space cable bundle supports every 0.9-1.2 meters at irregular intervals.

Leviton trunks are pre-terminated with either a jack or plug. There are numerous advantages to using pre-terminated trunks, including factory testing.

## Data Centers — Leviton Solutions



## Wireless Access Points

IEEE 802.11ac defines the next generation of Wi-Fi, and succeeds 802.11n. While 802.11ac was approved in late 2013, 802.11ac-enabled smartphones, routers, and laptops have been on the market since 2012. Most people are already using phones and laptops capable of connecting at the higher speed and frequencies 802.11ac offers, and adoption rates have been much faster than the move from 802.11a/b/g to 802.11n.

Enterprise wireless access points (WAPs) and backbone cabling infrastructure will need to be upgraded to see the real benefits of 802.11ac. Standards have already been revised to support access point upgrades. In late 2013, TIA published TSB-162-A, Telecommunications Cabling Guidelines for Wireless Access Points, which revises recommendations for mounting and routing cable between LAN equipment and WAPs.



## Wireless Access Points — Cabling Recommendations

### WAP Cabling Structure

Based on a 12 Sq m Uniform Cell Size

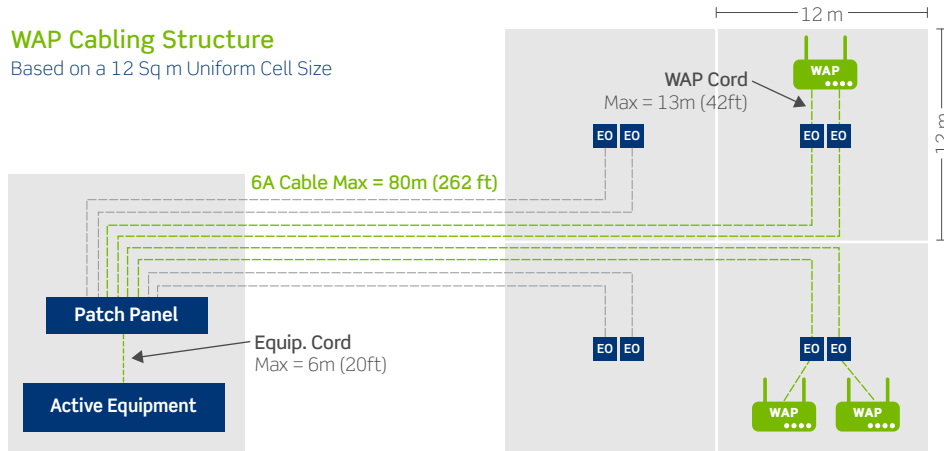

Install twisted-pair Cat 6A for horizontal cabling to WAPs. These high-bandwidth solutions can prepare wireless networks for the next waves of 802.11ac devices, as data rates grow from 433 kb/s to 6.9 Gb/s. By using a Cat 6A RJ-45 interface and twisted-pair structured cabling system, users get the added benefit of backwards compatibility and connection from the horizontal cabling all the way to the backbone and active gear.

Use grid-based zone cabling architectures, with each cell in the grid no greater than 12 meters wide. Many designs will likely use smaller grid cells — and in turn require additional WAPs — to improve data rates and allow for greater occupancy rates in each cell.

Run at least two Cat 6A cable runs to each cell in the grid architecture. As 802.11ac WAPs allow for Power over Ethernet (PoE), it is recommended to run two Cat 6A cables to each WAP for backup power capabilities in case one power source isn't working. Two cable runs will also prepare the infrastructure for future expansion and data requirements. Leviton also suggests installing shielded cabling for these PoE applications, as it reduces heat buildup in cable bundles that may contribute to performance issues.

## Wireless Access Points — Cabling Systems for WAPs



Leviton offers a complete in-ceiling system which includes patch cords, cable, Atlas-X1™ jacks, QuickPort® surface-mount boxes and In-Ceiling Mounting Brackets. Our cables are available in Construction Product Regulations (CPR) ratings Eca, Dca, Cca, or B2ca, ensuring you are fully compliant with local fire regulations.

The QuickPort in-ceiling mounting bracket provides a fixed location for terminating the data jack. This reduces the possibility of damage during construction. Contractors can perform the initial installation and permanent link testing, while allowing the flexibility to move the In-Ceiling Bracket to refine Wi-Fi® coverage or WAN placement without needing to retest the link.

## Wireless Access Points — Leviton Solutions



## Power over Ethernet

High-quality connectivity is essential for attaining the performance and reliability needed in current and future Power over Ethernet (PoE) network operations. System components should be designed to minimize temperature increases and meet industry standards for performance.





## Power over Ethernet — Standards

In late 2018, the IEEE 802.3bt standard was published, which defines PoE over four pairs and support for 10GBASE-T. The standard creates two new tiers of PoE: Type 3 for up to 60 watts, and Type 4 for up to 100 watts. Both support devices requiring higher power, such as laptops, displays, and next-generation wireless access points.

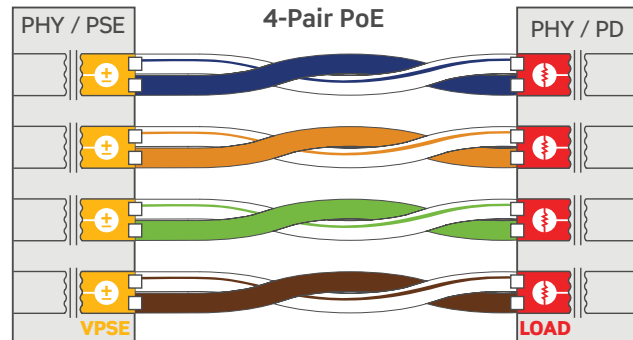

The Telecommunications Industry Association (TIA) and the International Organization for Standardisation (ISO) have updated standards that address cabling to support 4-pair PoE in accordance with 802.3bt. TIA TSB-184-A Guidelines for Supporting Power Delivery Over Balanced Twisted-Pair Cabling, the ISO/IEC TS29125:2017 “Information Technology — Telecommunications Cabling Requirements for Remote Powering of Terminal Equipment”, and CENELEC TR 50174-99-1 all offer cabling guidelines to support PoE, as well as other applications. These documents provide guidance on maximum bundle size for different category cables based on installation conditions and the maximum power delivered.

## Power over Ethernet — Cable and Connectivity Recommendations

One issue that can affect performance is heat generation in cable bundles. When power is added to balanced twisted-pair cabling, the copper conductors generate heat and temperatures rise. The heat dissipates into the surrounding area until a stable temperature is reached, with the cable bundle at a higher temperature than the surrounding ambient temperature. High temperatures can lead to higher insertion loss, and in turn shorter permissible cable lengths. It can also increase bit error rates, and create higher power costs due to more power dissipated in the cabling. Cables also behave differently with respect to heat dissipation depending on whether they are insulated in conduit, cable tray, or open air. Industry best practice is to limit the temperature rise of cables to no more than 15° C above ambient temperature and to keep the maximum operating temperature of all cables to below the maximum operating temperature of the manufacturer's specifications.

Leviton offers a white paper covering cable temperature rise in PoE installations.

[Leviton.com/NS/EMEA/PoE](https://www.leviton.com/NS/EMEA/PoE)

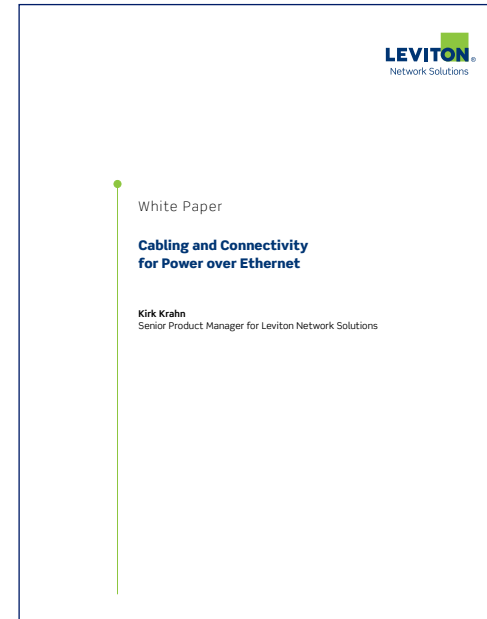

## Power over Ethernet — Cable and Connectivity Recommendations

### Reduce the Number of Cables per Bundle

Separating large cable bundles into smaller bundles or avoiding tight bundles will reduce temperature rise. For example, ISO/IEC 29175:2017 recommends separating large bundles into smaller bundles to reduce the maximum temperature rise (e.g. 3 × 37-cable bundles had a lower temperature rise than a 91-cable bundle). ISO document 14763 recommends a maximum bundle size of 24 cables, regardless of PoE considerations.

### Install Shielded Cabling

Test results from both Leviton and standards bodies show shielded cable performs better than traditional UTP cable. When Leviton engineers tested 24 cable bundles under temperature rise, the average temperature for shielded bundles increased at a rate 2 degrees Celsius below the UTP cable bundles. ISO/IEC testing reveals similar results.

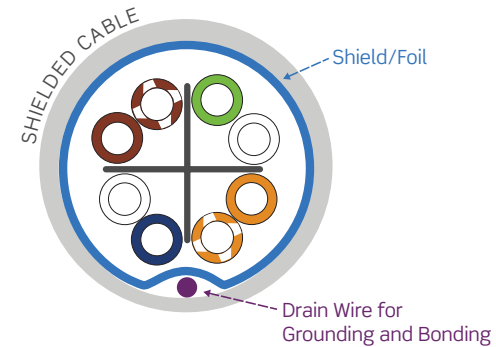

## Power over Ethernet — Cable and Connectivity Recommendations for PoE

### Consider Connection Integrity and Performance

Another consideration with PoE is the potential for damage over time to RJ-45 jacks in the network. Specifically, when a patch cord is unplugged while the connection is energized, a small electrical arc can occur between the jack and the plug. While there is no immediate damage (and the arc is not dangerous to users), it can create pitting on the jack tines and patch cord plug contacts over numerous disconnections, weakening the integrity of the connection.

Leviton recommends using a jack that is designed to keep the connection point between the mated jack tines and plug at a distance from the point of arcing damage. Leviton has designed the geometry of its jacks so that arcing occurs at a different area from the point of contact during data transmission. Leviton jacks also use a patented retention force technology that maintains contact force between the plug and jack, preventing intermittent disconnects that cause arcing.

As with cable, temperature rise in jacks can also affect channel performance. Leviton engineers tested Atlas-X1 jacks and patch cords against standards requirements. The jack was tested to the IEC 60512-5-2 Jacks for Electronic Equipment standard. The higher performance in the Atlas-X1 jack is largely due to its unique metal-body construction. Leviton testing found that using metal in the jack body — instead of commonly-used ABS plastic — creates a 53 percent improvement in heat dissipation.

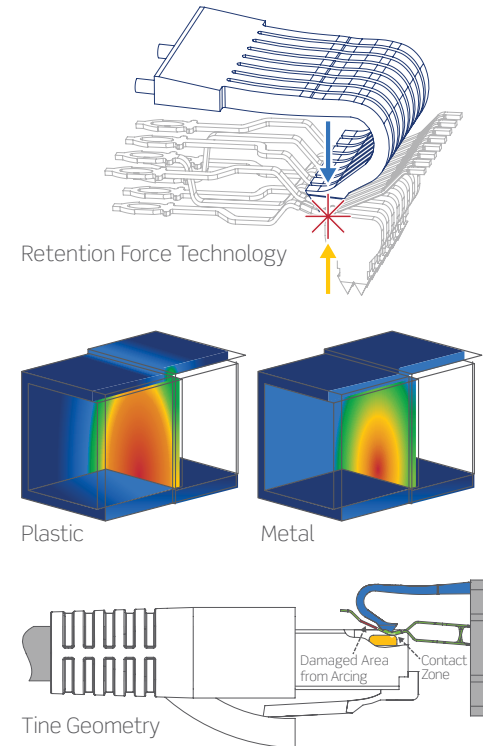

## Power over Ethernet — Leviton Solutions



## AV and HDBaseT™





HDBaseT has become a key technology that enables audiovisual signal extension to high definition displays and projectors. HDBaseT 5Play™ extends HDMI® video and audio, 100BaseT Ethernet, control, and power up to 100 meters on a single category-rated twisted-pair cable. Category cable is not only faster and simpler to install than traditional HDMI cables, it is also more cost effective.

AV signals over HDBaseT look much like the 10GBASE-T data signals you encounter every day — they are just a little less forgiving. HDBaseT is packet based like Ethernet, but it doesn't have a retransmission mechanism, so there is no recovery from packet errors. You can avoid pixelation or complete video dropout due to packet errors by using the right cabling.

A key feature of HDBaseT 5Play is the ability to power transmitter and receiver devices over the category cable link using PoH (Power over HDBaseT). Typical power levels used are only 10-15 watts, but the system is capable of supporting the full 100 watts in compliance with the IEEE PoE+ standard. A Category 6A connectivity system is recommended.

### HDBaseT 5Play at a Glance

Simultaneous transmission of 5 functions over a single category cable up to 100 meters (328 ft)

	<b>HD Video</b> — Full HDMI: HD/3D and 2K/4K uncompressed video
	<b>Audio</b> — Full audio including Dolby Digital, DTS, Dolby TrueHD, and DTS HD-Master Audio formats
	<b>Ethernet</b> — Supports 100Mb Ethernet Channel. For connecting devices to the local area network; can also be utilized to enable IP control of devices
	<b>Control</b> — Control via bi-directional RS-232 and IR Channels
	<b>Power over HDBaseT (PoH)</b> — Power extenders from either the source or display end with certified bi-directional PoH extenders. Complies with IEEE802.3at-2009 “PoE+”

## AV and HDBaseT™

The HDBaseT Alliance specifies Cat 5e, Cat 6 UTP, and Cat 6A UTP cabling as supported media types. But these category ratings will deliver varying performance results, depending on the type of installation, video resolution, and distance. While Cat 5e channels can carry HDBaseT signals in an isolated point-to-point link, they do not support HDBaseT in real-world high-density installations with adjacent data or HDBaseT channels.

Leviton testing finds use of Cat 5e in these applications can lead to high packet error rates and total link loss, as the channels are not designed for resistance to alien crosstalk. Even Cat 6 cables can be limited in carrying HDBaseT signals when adjacent to other cables carrying HDBaseT. We recommend Cat 6A to support HDBaseT signals that are in the presence of multiple disturbers, including other HDBaseT signals and 10 Gigabit Ethernet (GbE).

	CAT 5E UTP	CAT 6 UTP	CAT 6A UTP	CAT 6A SHIELDED
Recommended	No	No	Yes for Single Links	Yes
Typical Outer Diameter	5.3 mm (Typical)	5.7 mm (Typical)	7.6 mm	7.1 mm
Typical Guaranteed PSANEXT Margin	Not Designed to Mitigate Alien Crosstalk	Not Designed to Mitigate Alien Crosstalk	1 dB	16 dB
Grounding or Bonding Required	No	No	No	Yes

## Testing



## Testing



## Cat 6A Testing

Field testing of Cat 6A installations is much like field testing for Cat 5e and Cat 6. However, Cat 6A testing is performed to a maximum frequency of 500 MHz. In addition, Cat 6A adds several tests for alien crosstalk (AXT).

Use an industry-recognized field tester capable of testing to 500 MHz. Contact the test equipment manufacturer for any necessary hardware or software upgrades, including AXT testing capabilities, for testing Cat 6A installations. Perform permanent link or channel tests for all installed drops. Upon completion, provide the customer with all test results.

- Wire map
- Length
- Attenuation
- Propagation delay
- Delay skew
- NEXT - near-end crosstalk
- FEXT - far-end crosstalk
- Return loss (RL)
- PSNEXT - power sum near-end crosstalk
- PSFEXT - power sum far-end crosstalk
- PSACRF - power sum attenuation-to-crosstalk ratio, far-end
- AACRF - alien attenuation-to-crosstalk ratio, far-end
- AFEXT - alien far-end crosstalk
- ANEXT - alien near-end crosstalk
- PSAFEXT - power sum alien far-end crosstalk
- PSANEXT - power sum alien near-end crosstalk
- ELFEXT (ACRF) - equal level far-end crosstalk (attenuation-to-crosstalk ratio, far-end)
- PSELFEXT (PSACRF) - power sum equal level far-end crosstalk (power sum attenuation-to-crosstalk ratio, far-end)
- PSAACRF - power sum alien attenuation-to-crosstalk ratio, far-end

## AXT Testing

### PSANEXT

Power Sum Alien Near End Crosstalk



### PSAACRF

Power Sum Alien Attenuation to Crosstalk Ratio — Far End

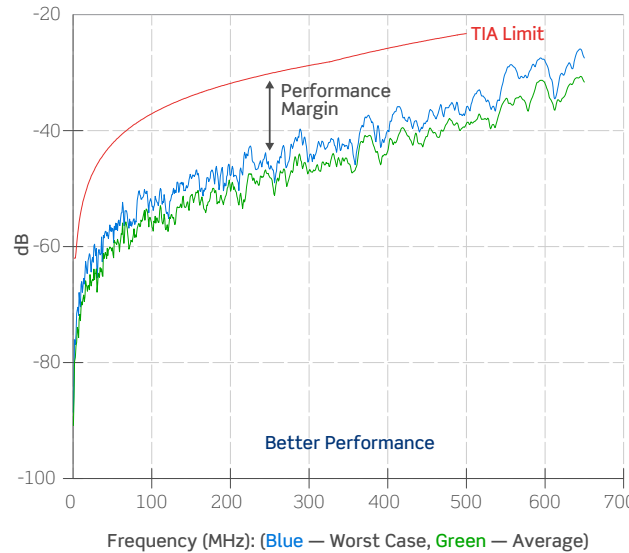

### TECH TIP: Leviton AXT Performance

Alien crosstalk (AXT) can have a serious impact on Cat 6A cabling system performance. Choose Leviton and get excellent AXT suppression. Independent third-party and Leviton tests have proven that properly installed Leviton Cat 6A solutions have significant AXT headroom over the standard's requirements, even for permanent links as short as 3 meters. As a result, properly installed Leviton systems with approved cable do not require field alien crosstalk testing. In addition, Leviton pre-terminated, pre-tested trunk cables do not require any field testing.

## AXT Testing Preparation

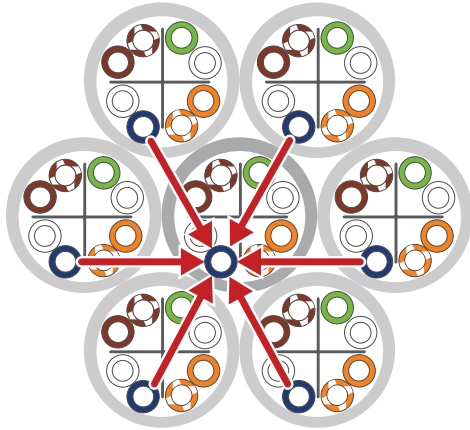

AXT testing measures the unwanted noise coupled to the cable being tested (called the “Victim” or “Disturbed”) by surrounding cables (called “Disturbers”). Two tests need to be performed: the Power Sum Alien Near-end Crosstalk (PSANEXT) test and the Power Sum Alien Attenuation-to-Crosstalk Ratio, Far-end (PSAACRF) test. Results for the remaining AXT tests are taken as part of these two, so although they are not directly provided, a “pass” result for PSANEXT and PSAACRF ensures passing results for AACRF, AFEXT, ANEXT, and PSAFEXT. A 2% sample of the installed cables is typically recommended.

- AXT tests are time-consuming: budget AXT test time into your bid
- Handheld test instruments (field testers) require an additional AXT module
- A laptop computer is also typically used with the field tester
- The field tester’s AXT application software must be loaded onto the laptop
- Installation personnel will require training prior to performing AXT testing

### TECH TIP: Is AXT Testing Required?

Even though Leviton does not require field AXT testing for its Cat 6A solutions, you may still be required to perform this testing. Read project specifications carefully to determine if they call for field AXT testing. If they do, ask for a waiver based on the proven performance of Leviton’s Cat 6A solutions. If the customer won’t grant a waiver, you’ll need to perform the testing.

## Product Overview



## Product Overview

## Jacks



Atlas-X1™ QuickPort®  
UTP and Shielded



eXtreme® QuickPort  
UTP



10GPlus  
Shielded



10GPlus  
UTP

### Atlas-X1™ QuickPort

Atlas-X1 Cat 6A jacks deliver the highest level of verified performance and reliability, and offer simple tool-free terminations. The jacks feature interchangeable icons and optional internal shutters for protection. They have been tested and approved as a in-ceiling solution for air-handling spaces, and can deliver up to 100-watt Power over Ethernet.

### eXtreme® QuickPort

eXtreme Cat 6A jacks pair high quality and performance with a user-friendly design to support fast, easy installations. They are ideal for enterprise or commercial environments where enhanced 10GBASE-T performance is required.

### 10GPlus Tool-Free

10GPlus offers proven performance and simple installation for streamlined deployment. The tool-free design requires no specialized termination tools.

## CAT 6A JACK OPTIONS

DESCRIPTION		UTP	SHIELDED
Atlas-X1	Cat 6A QuickPort Jack	6AUJK-R*6	6ASJK-R*6
	Cat 6A QuickPort Jack with Shutter	6AUJK-S*6	6ASJK-S*6
	Bulk Icons, pack of 72 (2-sided icons, 24 of each icon)	ICONS-IC*	ICONS-IC*
	Wire Managers, bag of 10	AXUJK-BWM	AXSJK-BGM
eXtreme	Cat 6A UTP Channel-Rated QuickPort Jack	6110G-R*6	—
10GPlus	Cat 6A Tool-Free Snap-In Jack	AC6JAKU002	AC6JAKS000DC

\* Color: White (W), Light Almond (T), Ivory (I), Yellow (Y), Orange (O), Crimson (C), Dark Red (R), Purple (P), Blue (L), Green (V), Grey (G), Black (E), Brown (B)

All Leviton Category-Rated Jacks are RoHS Compliant.

## 13 Colors and Shutter Options

## Patch Panels



e2XHD



QuickPort



10GPlus



Snap-In Jack

**e2XHD** — Simple termination and improved cable routing. Cassettes quickly snap in and pull out of high-density panels, making installation and maintenance easier than ever. Panel covers and cassette blanks offer extra protection against dust and damage.

**QuickPort** — Wide selection of panels allows you to create the perfect mix of voice, data, video, and audio, all in a single panel.

**10GPlus** — Shielded panels accept four removable modules with six ports each. The panels are available in 1RU and 0.5 RU sizes, and use standard LSA IDC termination.

**Snap-In-Jack** — Modular design accepts QuickPort jacks and 10GPlus Tool-Free jacks. Options include 24-port inline, an angled port option, and a colored insert option that allows for individual port/service identification.

### PATCH PANEL OPTIONS

TYPE		1RU 24 PORT	1RU 48 PORT	2RU 48 PORT	CASSETTE
e2XHD	Flat*	—	E2X1F-E48	—	E2XHD-BRK
	Angled*	—	E2X1A-E48	—	E2XHD-BRK
QuickPort®	Flat, kitted with jacks ^	6910G-U24	—	6910G-U48	—
	Flat*	49255-H24	—	49255-H48	—
	Flat, shielded†	4S255-S24	4S255-D48	4S255-S48	—
	Flat with magnifying lens holder*	49255-L24	—	49255-L48	—
	Angled*	49256-H24	—	49256-H48	—
10GPlus	Angled, shielded†	4S256-S24	4S256-D48	4S256-S48	—
	Flat, empty*	AC6PNLC240K2M	—	—	AC6CPF060K
	Flat loaded*	AC6PNLF240K2M	—	—	—
Snap-In Jack	Flat, black*	MMCPNLX24SIJ2DCI	—	—	—

\* Sold empty, load with any Atlas-X1™ or eXtreme® QuickPort jacks

^ Kitted with eXtreme jacks

† Sold empty, load with Atlas-X1 shielded jacks

° Sold empty, load with any Atlas-X1™ QuickPort, eXtreme® QuickPort, or 10GPlus Tool-Free jacks

\* Also available in 0.5 RU size

## Patch Cords



### Cat 6A Stranded Patch Cords

These cords deliver premium performance for superior alien crosstalk (AXT) suppression and protection from electromagnetic and radio frequency interference (EMI/RFI). The low-profile boot allows for higher density blade connectivity.



### Cat 6A U/FTP Solid Patch Cords

These cords have U/FTP construction for exceptional AXT suppression. The low profile boot allows for higher density blade connectivity.

### CAT 6A PATCH CORD OPTIONS

TYPE	YELLOW	RED	BLUE	GREEN	GREY	VIOLET
Stranded	AC6PCG0x0-688HB	AC6PCG0x0-188HB	AC6PCG0x0-488HB	AC6PCG0x0-588HB	AC6PCG0x0-888HB	—
U/FTP Solid	—	—	—	—	—	AC6PCG##0-788HBS*

× Length: 1 (1), 2 (2), 3 (3), 5 (5) meters, additional lengths available.

## Length: 10 (10), 20 (20), 30 (30), 40 (40), 50 (50), 60 (60) meters

\* Violet color is for Eca. Other CPR EuroClass options available. See [Leviton.com/NS/EMEA](http://Leviton.com/NS/EMEA) for more options.

Also available in white, violet, and black. Non-standard color and length options are available to order on request.

Note: Boots are only available in Slate Grey. If boot coloring is required, a Retrofit colored boot clip can be purchased separately.



### RETROFIT PATCH CORD CLIPS

DESCRIPTION	YELLOW	RED	BLUE	GREEN
Bag of 100	MMCPCHB006	MMCPCHB001	MMCPCHB004	MMCPCHB005

## Pre-Terminated Copper Trunks



Shielded e2XHD to Shielded e2XHD Trunk



UTP Jack to UTP Jack

Leviton makes it easy to configure your own copper trunks, customized for length, jack type, and more. With factory testing and no need for field terminations, you can reduce installation time by up to 75%.

- Built in dedicated make-to-order U.K. facility
- 100% factory tested, with test results available for each link
- Available with e2XHD Cassettes, work exclusively with e2XHD Patch Panels

### PRE-TERMINATED COPPER TRUNK OPTIONS

CABLE TYPE	CPR RATING	CABLE COUNT	TERMINATION	ICON	JACK COLOR	TRUNK LENGTH (METERS)	BREAKOUT LENGTH (METERS)	BREAKOUT ALIGNMENT
Cat 6A U/FTP Zone	B2ca, Cca, Eca	6-way 12-way	e2XHD Cassette with Shuttered Jacks	AV	Black Blue White	3-67	0.5	Even Staggered Staggered in pairs
Cat 6A U/FTP	Cca, Eca		e2XHD Cassette with Shielded Jacks	Blank				
Cat 6A S/FTP	B2ca, Cca, Eca		Plug Shielded Jack Shielded Jack with Shutters	Computer Data Phone Voice		3-90		



For assistance customizing your trunks, please visit [Leviton.com/NS/EMEA/MTO](https://www.leviton.com/NS/EMEA/MTO) or call Customer Service at +44 (0) 1592 772124.



## Cable

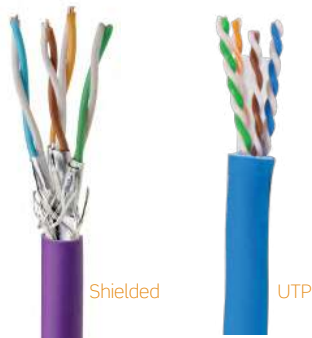

CABLE OPTIONS					
DESCRIPTION	EUROCLASS B2ca	EUROCLASS Cca	EUROCLASS Dca	EUROCLASS Eca	
Shielded	Cat 6A S/FTP, LSHF/LSZH	AC6S/FTP-HF1-B2ca-xxxOR	AC6S/FTP-HF1-Cca-xxxGN	AC6S/FTP-HF1-Dca-xxxBU	AC6S/FTP-HF1-Eca-xxxVT
	Cat 6A F/FTP, LSHF/LSZH	AC6F/FTP-HF1-B2ca-xxxOR	AC6F/FTP-HF1-Cca-xxxGN	AC6F/FTP-HF1-Dca-xxxBU	AC6F/FTP-HF1-Eca-xxxVT
	Cat 6A U/FTP, LSHF/LSZH	—	AC6U/FTP-HF1-Cca-xxxGN	AC6U/FTP-HF1-Dca-xxxBU	AC6U/FTP-HF1-Eca-xxxVT
UTP	Cat 6A U/FTP Zone, LSHF/LSZH	AC6-DCZ-B2ca-xxxOR	AC6-DCZ-Cca-xxxGN	AC6-DCZ-Dca-xxxBU	AC6-DCZ-Eca-xxxVT
	Cat 6A U/UTP Reuleaux, LSHF/LSZH	AC6U-HF1-B2ca-xxxOR	AC6U-HF1-Cca-xxxGN	AC6U-HF1-Dca-xxxBU	AC6U-HF1-Eca-xxxVT
	Cat 6A U/UTP Cable LSHF/LSZH	AC6U-HF1-B2ca-xxxOR1	AC6U-HF1-Cca-xxxGN1	—	—

xxx Reel Length: 500 (500), 1000 (1000) meters

### Cat 6A Shielded Cable

- Available in multiple screened constructions, providing EMI shielding
- Range of sheath materials suit a variety of installation environments, including CPR fire performance ratings Eca, Dca, Cca and B2ca, and colour coded for identification
- Optimum electrical performance to standards ISO/IEC 11801-1 Class E<sub>A</sub>, IEC 61156-5, EN 50173-1 and EN 50288-10-1, and ANSI/TIA-568.2-D
- Recommended for PoE standards: IEEE 802.3af, 802.3at, 802.3bt, Cisco UPoE, and Power over HDBaseT™ (PoH) up to 100 watts

### Cat 6A Unshielded Cable

- Range of sheath materials suit a variety of installation environments, including CPR fire performance ratings Eca, Dca, Cca and B2ca, and colour coded for identification
- Optimum electrical performance to standards ISO/IEC 11801-1 Class E<sub>A</sub>, IEC 61156-5, EN 50173-1 and EN 50288-10-1, and ANSI/TIA-568.2-D
- Recommended for PoE standards: IEEE 802.3af, 802.3at, 802.3bt, Cisco UPoE, and Power over HDBaseT™ (PoH) up to 100 watts

## Faceplates and Housings



## UK-Style Faceplates, Back Boxes, and Modules

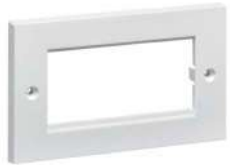

Modular Faceplate



Shuttered Faceplate



Double-Gang Back Box



Blank Module



Shuttered Module



Angled Module

Ideal for wall and trunking applications, these faceplates and modules can be used with select Leviton Snap-In Jacks and QuickPort Jacks. The faceplates come with M3.5 mounting screws and are available in both modular or shuttered versions

### FACEPLATE OPTIONS

#### DESCRIPTION

Modular, white\* MMCWDOUNI03x

Shuttered, white, 86 x 86 mm\* MMCWDOUNI07#

x 86 x 86 single gang (0), 86 x 147 double gang (1)

# 1 port (0), 2 port (1)

\* Compatible with Atlas-X1™, eXtreme®, and 10GPlus Cat 6A shielded and UTP jacks

### BACK BOX OPTIONS

#### DESCRIPTION

44 MM DEEP

32 MM DEEP

Single-Gang, white

MMCSGBB44001

MMCSGBB32001

Double-Gang, white

MMCDGBB44002

MMCDGBB32002

### MODULE OPTIONS

#### DESCRIPTION

12.5 X 50 MM

25 X 50 MM

50 X 50 MM

Blank, white

MMCWDOUNI052

MMCWDOUNI042

MMCWDOUNI040

Shuttered Module, white\*

—

MMCWDOUNI062

—

Angled Module, white\*

—

MMCANG0623

—

\* Compatible with Atlas-X1™, eXtreme®, and 10GPlus Cat 6A shielded and UTP jacks

## Continental Outlets, Faceplates, and Modules



Snap-In-Jack Module



Angled Snap-In-Jack Module

### France, Spain, and Portugal

These modules accept Leviton QuickPort and 10GPlus jacks, and are compatible with Mosaic™-style faceplates with a 45 x 45 mm aperture. A Mosaic style faceplate is also available, with a 45 x 45 mm aperture.

#### FRANCE, SPAIN, AND PORTUGAL OPTIONS

DESCRIPTION		80 X 80 MM	
Faceplate and Backbox	Mosaic-Style Faceplate, white*	MMCWDOUNI115	
	Back Box, white*	MMCWDOUNI116	
DESCRIPTION		1 PORT	2 PORT
Modules	Snap-In-Jack, white*	MMCUNILGS45001	MMCUNILGD45001
	Angled Snap-In-Jack, 45 x 45 mm, white*	MMCANGLGS45002	MMCANGLGD45002

\* Compatible with Atlas-X1™, eXtreme®, and 10GPlus Cat 6A shielded and UTP jacks



2 Port



3 Port with ID Window



4-Port with Brand-Rex Logo

### Italy

Italian style faceplates are available with 2, 3, 4, or 6 ports. The 2 and 3 port faceplates are offered in a horizontal alignment.

#### ITALY OPTIONS

DESCRIPTION	
70 x 115 mm Horizontal Faceplate, white*	41070-xWS
70 x 115 mm 4-Port Faceplate with Brand-Rex Logo, white*	MMCUSSIJ4001LO☐
70 x 115 mm 6-Port Faceplate with Brand-Rex Logo, white*	MMCUSSIJ6001LO

☒ x 2 port (2), 3 port with ID window (3) ☐ For icon options add "ICO" to end of part number

\* Compatible with Atlas-X1™, eXtreme®, and 10GPlus Cat 6A shielded and UTP jacks

## Continental Outlets, Faceplates, and Modules

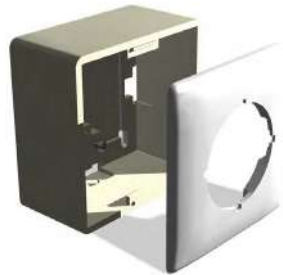

80 x 80 Faceplate  
and Back Box

### German-Style Outlets

These shielded modules can be flush or wall mounted using the 80 x 80 mm faceplate and backbox. The 50 x 50 mm Snap-in-Jack Modules have an angled design to reduce bending stresses on cable.



2-Port 10GPlus Cat 6A  
Shielded Module

### GERMAN-STYLE OUTLET OPTIONS

DESCRIPTION		IVORY	WHITE
80 x 80 mm Faceplates and Backbox	Faceplate and Back Box	07058GE	07058GF
	S95 Type Faceplate	18985JV	18985JW
Modules	2-Port 10GPlus Cat 6A Shielded	AC6G245U001	AC6G245SU002
	1-Port 50 x 50 mm Snap-in-Jack*	—	MMCANGDK1453
	2-Port 50 x 50 mm Snap-in-Jack*	—	MMCANGDK2453
	3-Port 50 x 50 mm Snap-in-Jack^	—	MMCANGDK3453

\* Compatible with Atlas-X1™, eXtreme®, and 10GPlus Cat 6A shielded and UTP jacks

^ Compatible with 10GPlus Cat 6A shielded jack

## QuickPort® Surface-Mount Boxes and In-Ceiling Bracket



QuickPort Surface-Mount Box  
12-Port Standard



QuickPort Surface-Mount Box  
Extended Depth 2-Port Plenum-Rated

### QuickPort Surface-Mount Boxes

Surface-Mount QuickPort Boxes are easily field-configured with QuickPort Jacks. All boxes can be mounted with screws or adhesive mounting tape (both provided) or with magnets or modular furniture brackets (sold separately). One-, two-, and four-port surface-mount boxes are plenum rated for use in air-handling spaces. Extended depth 4S089 boxes are best suited for use with Cat 6A cable.

#### SURFACE-MOUNT BOX OPTIONS

DESCRIPTION	
Standard*	41089-xxx
Extended Depth <sup>^</sup>	4S089-#WP

xxx 12-Port, 193 x 128 x 29 mm (12W); 6-Port, 162 x 82 x 27 mm (6WP); 4-Port, 121 x 82 x 27 mm (4WP); 2-Port, 64 x 56 x 28 mm (2WP); 1-Port, 36 x 56 x 28 mm (1WP)  
# 2-Port, 64 x 76 31 mm (2), 4-Port, 142 x 132 x 31 mm (4)

\* Compatible with Atlas-X1™ and eXtreme® Cat 6A shielded and UTP jacks.

<sup>^</sup> For shielded jacks and large bend-radius cables. Compatible with Atlas-X1™ and eXtreme® Cat 6A shielded jacks.



QuickPort In-Ceiling Bracket

### QuickPort In-Ceiling Bracket

This bracket provides a fixed location for terminating a data jack, creating a more reliable connection than a direct connect plug. It also reduces potential damage during construction. Contractors can perform the initial installation and permanent link testing and have the flexibility to move the bracket to refine Wi-Fi® coverage or WAN placement without needing to retest the link.

#### QUICKPORT IN-CEILING BRACKET OPTIONS

DESCRIPTION	
Includes clip for drop wire/rod mounting*	49223-CBC
No clip*	49223-CB0

\* Compatible with Atlas-X1™, eXtreme®, and 10GPlus Cat 6A shielded and UTP jacks

## Multimedia Outlet System (MOS)



Surface-Mount Box,  
3-Unit with Fiber Storage



Surface-Mount Box,  
1-Unit



VGA PC Module



HDMI Module



1-Port QuickPort Module



2-Port QuickPort Module

MOS provides a clean and flexible system to integrate data and AV modules in a surface-mount box. The box can be positioned vertically or horizontally, depending on port exit preference.

### MOS OPTIONS

DESCRIPTION	WHITE	
Surface-Mount Boxes	3-Unit with Fiber Storage	41296-MMW
	1-Unit	4M089-1WM
AV Connector Modules	VGA / HD15 Module, feedthrough	41293-HDW
	HDMI Module, feedthrough	41290-HDW
Blank Modules	1-Port QuickPort Module*	41291-1MW
	2-Port QuickPort Module*	41291-2QW

\* Compatible with Atlas-X1™ and eXtreme® Cat 6A shielded and UTP jacks and MOS AV modules

## Cable Management



8" x 8" Channel  
(Front, Rear, and shown  
with optional Designer Cover)



5" x 4" Channel  
(Front Only)



1RU  
Horizontal



### Versi-Duct®

Versi-Duct is a versatile cable management solution that fits on any standard equipment rack and includes accessories for a wide range of cable management configurations. The vertical 8-inch and 5-inch managers have large finger passthrough spaces that align with rack units.

### VELCRO® Brand Fasteners

VELCRO® Brand products won't crush or damage cables like tie wraps can, and are reusable for moves, adds, and changes.

### VERSI-DUCT® CABLE MANAGERS

DESCRIPTION	FRONT ONLY	FRONT AND REAR	
8" x 8" Vertical Channel	80" (2.03 m) Length, standard cover, black	8980L-VFO	8980L-VFR
	Center-Mount Bracket	—	89265-BKT
	Slack Loop Organizer	—	89265-SL1
	Cable Retainer	—	89265-WR1
	Designer Cover, grey (Set of 2)	—	89265-8DC
5" x 4" Vertical Channel	80" (2.032 m) Length, standard cover, black	4980L-VFO	4980L-VFR
	40" (1.016 m) Length, standard cover, black	4940L-VFO	4940L-VFR
	Center-Mount Bracket	—	49265-BKT
Horizontal	Designer Cover, grey	—	59265-5DC
	2RU, black cover	492RU-HFO	492RU-HFR
	1RU, black cover	491RU-HFO	491RU-HFR
	2RU Designer Cover, grey	—	49265-DC2
	1RU Designer Cover, grey	—	49265-DC1
Cable Retainer	—	49265-WR1	

### VELCRO® BRAND FASTENERS

DESCRIPTION	BLACK	
Tie Wrap	5" (127 mm)	43105-005
	8" (203 mm)	43108-008
	12" (305 mm)	43112-012
Bulk Roll	15' (4.57 m)	43115-015
	75' (22.86 m)	43115-075
	600' (182.88 m)	43115-600
	75' (22.86 m) SoftCinch Lite Roll	4S115-75E

Leviton offers a wide variety of cable management solutions; for a full list please visit [Leviton.com/NS/EMEA/CableManagement](https://www.leviton.com/NS/EMEA/CableManagement)



## Cat 6A Termination

Leviton has designed several exclusive features into its Cat 6A jacks to speed termination. Read on for details of these features, other tips for a seamless installation, and for termination instructions for our UTP and shielded jack.

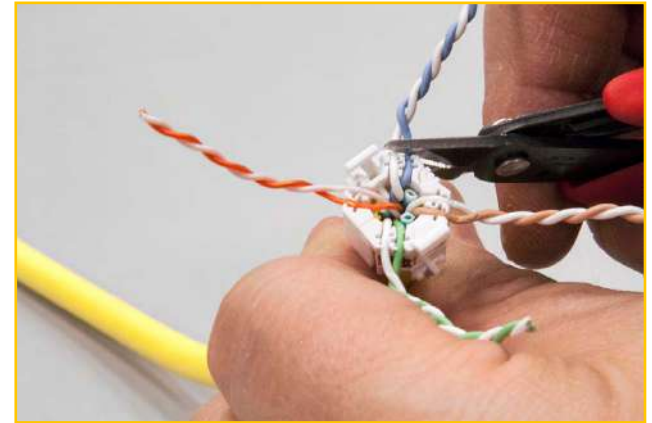

### Termination

## Termination Tips



### Extra Cable for Re-Terminations

Industry standard recommend storing 3 meters (10 ft) of extra cable in the telecom room and 30-45 centimeters (12-18 in) above work area installations for re-terminations and to accommodate moves, adds, and changes. Use an extended or figure 8 loop configuration to alleviate cable stress. Cable slack in bundled or excessive loops has been shown to degrade cable performance and is associated with return loss failures.

**TECH TIP:** Using Icons in Atlas-X1 Jacks

One of the unique benefits of Leviton Atlas-X1™ jacks is the ability to add icons to the front of the jack that designate specific applications, such as data, voice, and AV. These matching-color icons are provided with each jack.

First, select the desired icon. Then, trim away any residual plastic vestige from the icon packaging, and press the icon securely into the front of the jack.

If you want to remove an icon from the front of a jack, simply unbend a small paper clip, insert the end of the clip into the icon release hole, and gently pry outward.

Bulk orders of 72 icons are also available. They come in 13 colors, and a package includes 24 of each icon. Use part number ICONS-IC\* (the asterisk represents the color choice).

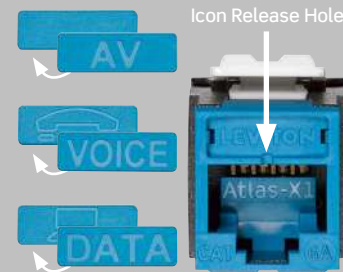

**TECH TIP:** Leviton Palm Termination Tool

Use Leviton's Palm Termination Tool to quickly and easily punch down eXtreme® Cat 6A jacks at the jobsite. The Palm Tool offers an ergonomic comfort grip, increased jack stability, and integrated holes that allow rack mounting for QuickPort® panel terminations.

Videos — get simple termination instructions at the [Network Solutions YouTube page](#).

## Atlas-X1™ UTP Jack Termination Instructions

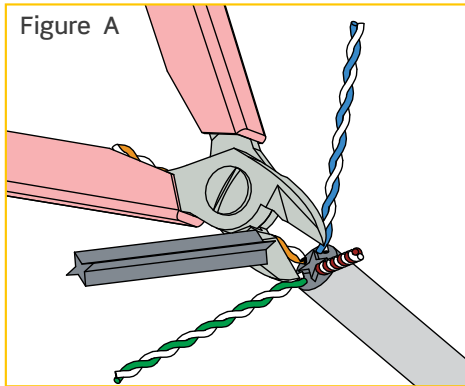

- 1 Using a cable stripper, remove 38 millimeters (1.5 inches) of cable jacket. At the strip point of the cable, use flush cutters to carefully remove strip string, Mylar® tape, cross-shaped pair separator, or any other cable fillers or spacers where applicable. (Figure A).

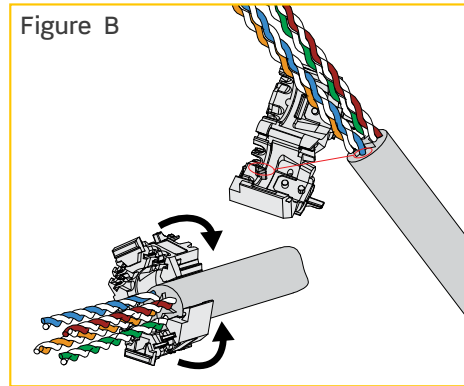

- 2 Line up the wire manager with the blue pair indication on the label in line with the blue pair of the cable. Ensure that the end of the cable jacket is at the cable jacket stop inside the wire manager and click the wire manager closed (Figure B).

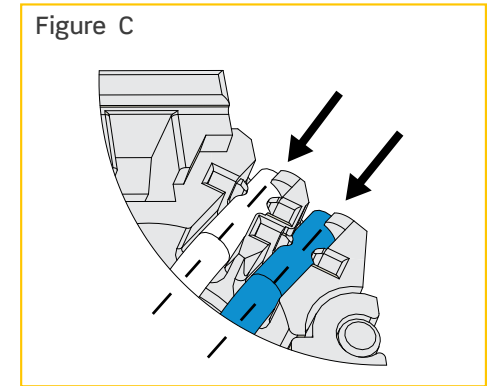

- 3 Observing pair polarity and T568A or T568B wiring pattern, seat the four pairs into the wire manager.

**Note:** Pairs must be completely and securely seated into wire manager wire channels (Figure C).

Continued...

## Atlas-X1™ UTP Jack Termination Instructions Continued

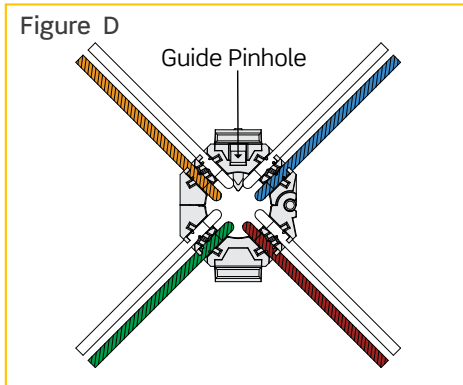

- 4** Check polarity by making sure the white wire of each pair will be closest to the guide pinhole in the face of the wire managers (Figure D).

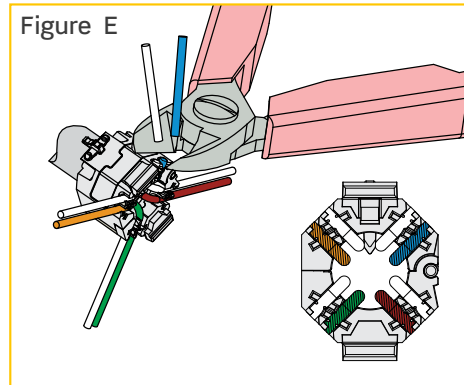

- 5** Using a flush cutter, trim all pairs flush with sides of wire manager.
- Note:** Wire ends must be cut flush: use of snips or side cutter is not recommended and may cause test failures (Figure E).

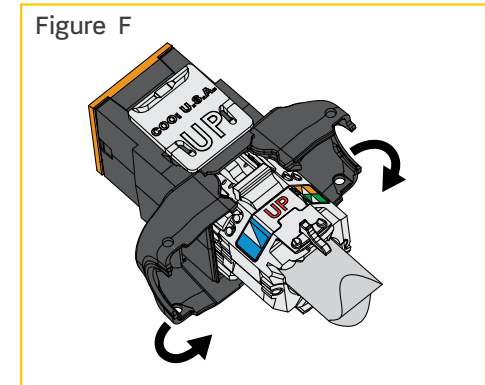

- 6** Align the prepared wire manager with the rear of the jack, matching “UP” on the wiring label to “UP” molded into the jack retaining tab (Figure F). Close jack doors to complete the termination. To rewire, depress the jack door-release tabs simultaneously.

## Atlas-X1™ Shielded Jack Termination Instructions

Figure A



Figure B

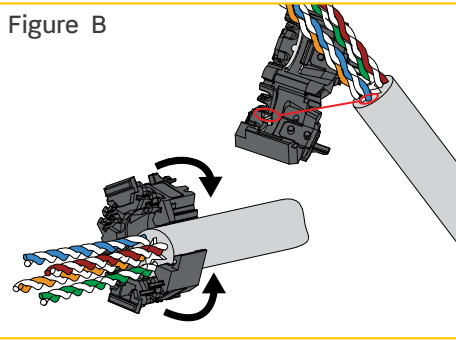
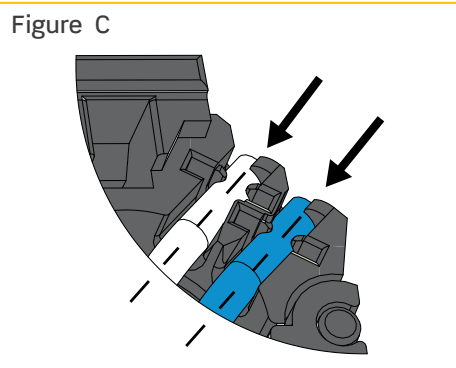

Figure C



- 1 Using an appropriate cable stripper, remove about 38 millimeters (1.5 inches) of cable jacket. Inspect shield foil and pairs to ensure no foil or insulation damage.
- 2 At the strip point of the cable, use flush cutters to carefully remove strip string, if one is present. Spare back the foil metal side outward. Spare back the drain wire (Figure A). Use flush cutters to remove Mylar® tape, cross-shaped pair separator, or any other cable fillers or spacers.
- 3 Line up the wire manager with the blue pair indication on the label in line with the blue pair of the cable. Ensure that the end of the cable jacket is at the cable jacket stop inside the wire manager, and click the wire manager closed (Figure B).
- 4 Observing pair polarity and T568A or T568B wiring pattern, seat the four pairs into the wire manager.

**Note:** Pairs must be completely and securely seated into wire manager wire channels (Figure C).

Continued...

## Atlas-X1™ Shielded Jack Termination Instructions Continued

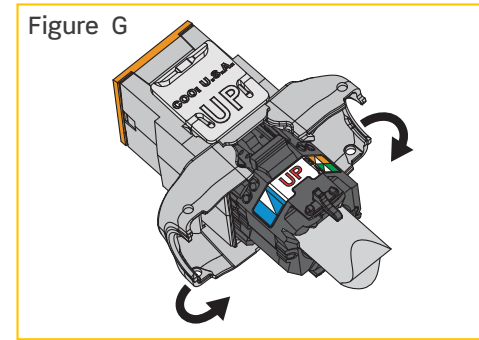
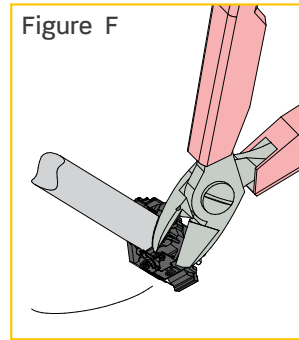
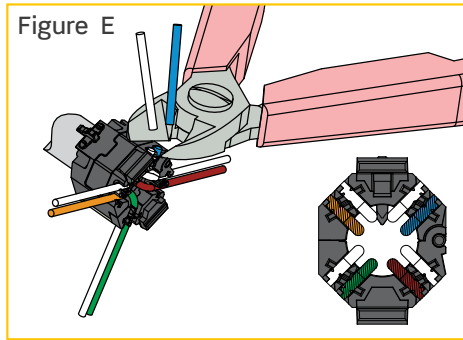
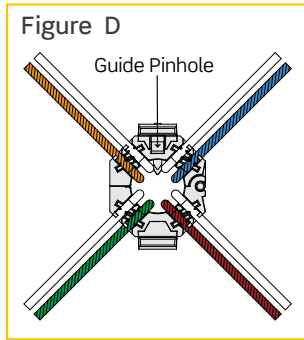

- 5** Check polarity by making sure the white wire of each pair will be closest to the guide pinhole in the face of the wire managers (Figure D).

- 6** Using a flush cutter, trim all pairs flush with sides of wire manager.

**Note:** Wire ends must be cut flush: use of snips or side cutter is not recommended and may cause test failures (Figure E).

- 7** Pull drain wire into drain wire capture notch and trim flush with flush cutter. Use flush cutter to nick edge of foil, and tear foil off flush with rear of wire manager (Figure F).

- 8** Align the prepared wire manager with the rear of the jack, matching “UP” on the wiring label to “UP” molded into the jack retaining tab (Figure G). Close jack doors to complete the termination. To rewire, depress the jack door-release tabs simultaneously.

## eXtreme® Cat 6A Jack Termination Instructions

Figure A

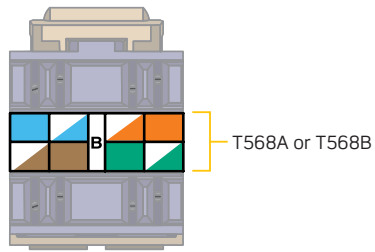

- 1 Remove about 76 millimeters (3 inches) of cable jacket and center spline (stiff plastic separator inside Cat 6A cable).
- 2 Determine whether to use wiring scheme T568A or T568B.

**Note:** the associated color codes and jack pin number on the label located between the IDC jack slots (Figure A). Peel back label for T568A wiring.

Figure B

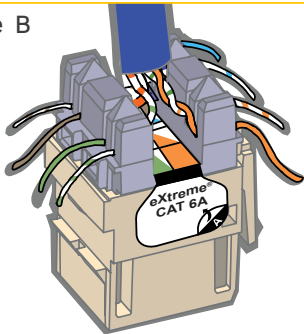

- 3 Leave the cable jacket within 3 millimeters ( $\frac{1}{8}$  inch) of the jack side, then route the wires for termination using the selected wiring scheme (Figure B). Route cable perpendicular to the IDC field. Ensure there is enough slack in the twisted pairs, and do not place the cable jacket into the termination field.

Continued...

## eXtreme® Cat 6A Jack Termination Continued

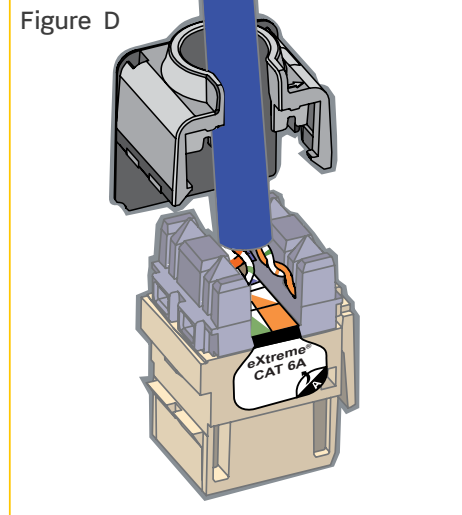
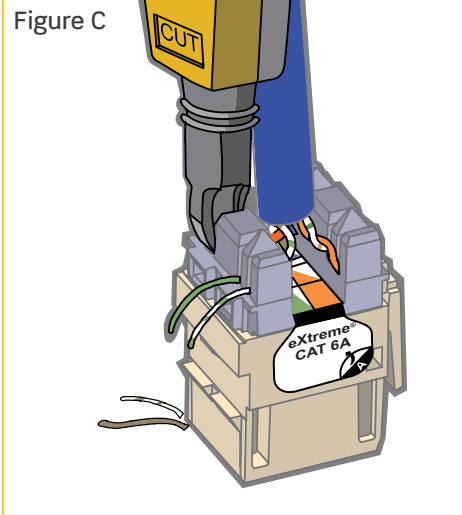

Use the punch down puck to terminate the jack first, then install into a patch panel or faceplate.

- 4 Use your fingers to carefully seat wires into the IDC slots. Maintain wire pair twisting to within ½" (13 mm) of the IDC. Set a 110-style impact tool to low and position it perpendicular to the jack. Seat and trim the cable one pair at a time to prevent crushing the inside pairs (Figure C).
- 5 Place the Cone of Silence® over the terminated wires for secure connection and exceptional Cat 6A performance (Figure D).





## Glossary

**10GBASE-T** (10 Gigabit baseband over twisted pair) » This IEEE standard, 802.3an, defines 10 Gigabit Ethernet running 10Gbps over balanced twisted-pair cabling.

**ANSI** (American National Standards Institute) » ANSI oversees the creation, circulation and use of standards and guidelines that directly impact businesses in various sectors. ANSI is also actively engaged in accrediting programs that assess conformance to standards.

**Attenuation** » The loss of volume during transmission, or decrease in the power of a signal, light beam, or light wave. Attenuation is the opposite of gain and is measured in decibels (dB).

**AWG** (American wire gauge) » The standard measuring gauge for nonferrous conductors (i.e., non-iron and non-steel). Gauge measures the diameter of a conductor (thickness of cable).

**AXT** (alien crosstalk) » Electromagnetic noise that can occur in a cable run alongside other signal-carrying cables. The term “alien” arises from the fact that this form of crosstalk occurs between different cables in a group or bundle, rather than between individual wires or circuits within a single cable.

**Bandwidth** » The difference between the highest and the lowest frequencies of a transmission channel (path for information transmission). Identifies the amount of data that can be sent through a given channel. Measured in hertz (Hz); higher bandwidth numbers mean higher data capacity.

**Bend Radius** » The amount of bend that can occur before a cable may sustain damage or increased attenuation.

**BICSI** (Building Industry Consulting Services International) » A non-profit professional association for the promotion of telecommunications industry standards and installation best practices.

**Category 5e** (enhanced category 5 or Cat 5e) » A standard for balanced twisted pair cable and components supporting signaling rates up to 100 MHz. Cat 5e is intended to support systems up to 1000BASE-T or Gigabit Ethernet up to distances of 100 m (328 ft).

**Category 6** (CAT 6) » A standard for balanced twisted pair cable and components supporting signaling rates up to 250 MHz. Cat 6 is intended to support systems up to 1000BASE-T or Gigabit Ethernet up to distances of 100 m (328 ft).

**Category 6A** (augmented category 6 or Cat 6A) » A standard for balanced twisted pair cable and components supporting signaling rates up to 500 MHz. Cat 6A is designed to support 10GBASE-T or 10 Gigabit Ethernet up to distances of 100 m (328 ft).

**Category of Performance** » Cabling and cabling component standards adopted by the telecommunications industry.

## Glossary

**CENELEC** (The European Committee for Electrotechnical Standardization) » CENELEC is responsible for standardization in the electrotechnical engineering field. It develops European Standards (ENs) and supports conformity with ISO (IEC) standards.

**Channel** » In the horizontal cabling portion of a structured cabling system, the channel contains all of the elements of the permanent link, plus the equipment cords at the horizontal cross-connect (HC) and the patch cords in the work area.

**Channel-rated** » Category-rated structured cabling components are said to be channel-rated if, when installed as a system in an industry-defined channel, they meet all of the transmission and noise characteristics defined in the standard. Compare with Component-rated.

**Compliance** » A wiring device that meets all characteristics of a standard is said to be in compliance with that standard.

**Component-rated** » Category-rated structured cabling components are said to be component-rated if they exceed all of the transmission and noise characteristics defined in the standard for an individual structured cabling component. Component specifications are more stringent than channel specifications and may provide greater permanent link and channel test margins. Compare with Channel-rated.

**Conductor** » Any substance, usually a wire or cable, that can carry an electrical current.

**Connecting Block** » Also called a terminal block, punch-down block, quick-connect block, or cross-connect block, this plastic block contains metal wiring terminals to establish connections from one group of wires to another. Usually each wire can be connected to several other wires in a bus or common arrangement. There are several types of connecting blocks: 66, 110, etc.

**Consolidation Point** » An optional location between an ER or TR and the workstation for interconnection of horizontal cables.

**CPR** (Construction Products Regulation) » For cabling, CPR sets fire safety classifications and requires that all cables marketed in the European Economic Area (EEA) to carry a CE mark and have a declaration of performance (DOP). The CE mark indicates the specific fire performance level that the cable has been verified to provide.

**Data Center (DC)** » A data center is a facility used for housing a large amount of electronic equipment, typically servers, computers, data storage devices, and communications equipment. Data centers are designed to assure that the equipment and data housed in them are protected from environmental hazards and security breaches. Data centers can be private, serving a single company, or a public “utility” serving a variety of companies.

## Glossary

**dB (decibel) »** A dB is a unit of measure of signal strength, usually the relationship between a transmitted signal and a standard signal source. Every 3dB equals 50% of signal strength, so therefore a 6dB loss is a loss of 75% of total signal strength.

**EF (entrance facility) »** An entrance to a building for both public and private network service cables (including wireless) including the entrance point of the building and continuing to the entrance room or space.

**Ethernet »** Leading local area network (LAN) protocol used for connecting computers, printers, workstations, terminals, etc. within the same building. Ethernet is a physical link and data link protocol that operates over twisted pair wire. See IEEE 802.3x.

**ER (equipment room) »** is a centralized space that houses telecommunications equipment. ERs generally serve an entire building or campus, while TRs (telecommunication rooms) serve one floor of a building or a portion of a floor. An ER may contain active equipment, cross-connect equipment, and building systems (e.g. life safety, security, electrical and HVAC).

**FTP (foiled twisted pair) »** Balanced twisted pair cable with an overall foil shield and drain wire. Also called screened twisted pair (ScTP) cable.

**F/UTP (foiled screened with unshielded twisted pairs) »** Overall shielded cable with no shield on individual twisted pairs.

**Gain »** An increase in signaling power when an electric device boosts the signal; measured in decibels (dB).

**Gigabit »** When used to describe data transfer rates, Gigabit refers to 10 to the 9th power (1,000,000,000) bits. Gigabit Ethernet, abbreviated GbE, supports data transfer rates of 1 Gigabit (1,000 megabits) per second. The first Gigabit Ethernet standard (802.3z) was ratified by the IEEE 802.3 Committee in 1998.

**HC (horizontal cross-connect) »** The HC is a location for the cross-connect of horizontal cabling to other cabling and equipment.

**HDBaseT »** A standard created by the HDBaseT alliance for delivering video, audio, power, Ethernet, USB and control signals over category-rated twisted pair copper cable.

**IC (intermediate cross-connect) »** The IC is a cross-connect point located between the MC (main cross-connect) and the HC in interbuilding backbone cabling.

## Glossary

**IDC (insulation displacement connection) »**

An IDC allows the termination of a conductor without stripping the conductor's insulation. When the conductor is inserted into the contact, the insulation is displaced, creating contact between the conductor and the IDC, producing a gas-tight connection.

**IEEE (Institute of Electrical and Electronics Engineers) »** A publishing and standards-making body responsible for many standards used in LANs.

**IEEE 802.11ac »** An IEEE wireless networking standard providing high-throughput wireless local area networks (WLANs) on the 5 GHz band, with theoretical speeds up to 6.9 Gb/s.

**IEEE 802.3 »** A collection of IEEE standards defining the physical layer and the media access control (MAC) sublayer of the data link layer of wired Ethernet. This is the most common local area network specification.

**IEEE 802.3an »** A standard for 10GBASE-T released in 2006 to provide 10 gigabit per second transmission over balanced twisted pair cables up to 100 meters (328 ft).

**IEEE 802.3bt »** An IEEE standard in development which will define Power over Ethernet over four pairs and support 10GBASE-T. The standard will define two new tiers of PoE: Type 3 for up to 60 watts, and Type 4 for up to 100 watts. Publication of 802.3bt is expected in 2018.

**Impedance »** The total opposition (i.e. resistance and reactance) a circuit offers to the flow of alternating current. It is measured in ohms, and the lower the ohmic value, the better the quality of the conductor.

**Insertion Loss (IL) »** The difference in the amount of power received before and after something is inserted into the circuit.

**Interconnect »** A circuit administration point, other than a cross-connect or an information outlet, that provides capability for routing and rerouting circuits. It does not use patch cords or jumper wires, and typically is a jack-and-plug device used in smaller distribution arrangements or that connects circuits in large cables to those in smaller cables.

**Intertek (ETL) »** An independent testing, inspection and certification laboratory that provides electrical safety, electromagnetic compatibility, benchmark and performance testing.

**ISO (International Standards Organization) »** The world's largest developer and publisher of international standards. It is a non-governmental organization (NGO) network of national standards institutes in 157 countries, based in Geneva, Switzerland.

## Glossary

**ISO/IEC** » ISO/IEC is a joint technical committee of the International Organization for Standardization and the International Electrotechnical Commission. The standard ISO/IEC 11801 Information technology — Generic cabling for customer premises specifies general purpose telecommunication cabling systems.

**Jack** » A device that connects wires or fibers in cable to equipment or other wires or fibers. Wire and optical jacks most often join transmission media to equipment or cross connects. Jacks are sometimes referred to as connectors or outlets.

**Jacket** (also cable jacket or sheath) » The outer covering applied over internal cable elements for protection.

**LAN** (local area network) » A LAN is a computer network covering a small physical area, generally a single building or contiguous campus. LANs are characterized by higher data-transfer rates (compared to a WAN or wide area network) and lack of leased telecommunications lines.

**Mbps** (megabits per second) » One million bits per second.

**MC** (main cross-connect) » The MC is the cross-connect in the ER (equipment room) for connecting entrance cables, backbone cables and equipment cables.

**MHz** (megahertz) » A unit of frequency denoting one million hertz (1,000,000 cycles per second).

**Mud Ring** » Industry jargon for a plaster ring/frame mounted in a wall to support a telecommunications outlet such as a faceplate. Essentially, mud rings are backless junction boxes.

**NEXT** (near-end crosstalk) » Electrical noise coupled from one pair of wires to another within a multi-pair cable.

**Patch Cord** » A cord made from 4-pair 100-ohm balanced twisted-pair cable. Patch cords may be shielded or UTP, depending on the type of system being installed. They are typically wired

T568 A or B with an 8-position, 8-conductor (8P8C) plug on each end. Work area and TR patch cords are made from stranded cable, which has better flexibility, durability and longer life than solid-conductor cords.

**Patching** » A means of connecting circuits via cords and jacks that can be easily disconnected and reconnected at another point. May be accomplished by using modular cords connected between jack fields or by patch cord assemblies that plug onto connecting blocks.

**Patch Panel** » A piece of connecting hardware designed for use in a standard 19" equipment rack or cabinet. Standard patch panels have modular jack appearances on the front, and 110-style IDC connections on the rear. Field-configurable patch panels can be loaded with a variety of jacks or other jacks for mixed-media installations, or where the use of various jack colors is desired.

## Glossary

**Performance** » The totality of a communication transmission's characteristics, including rate of transfer, barriers to peak transfer rate, and comparison to applicable standards. Compare with Compliance. A device can exhibit performance characteristics without being compliant to an industry standard.

**Permanent Link** » In the horizontal cabling portion of a structured cabling system, the permanent link contains the following: the telecommunications outlet (TO), the cabling between the horizontal cross-connect (HC) and the TO, an optional consolidation point (CP), and the connecting hardware at the HC.

**Power over Ethernet (PoE)** » PoE technology describes any system capable of transmitting electrical power, along with data, to remote devices over standard twisted-pair cable in an Ethernet network. This technology is useful for powering IP telephones, wireless access points, security cameras, and other appliances where it would be inconvenient or infeasible to supply power separately.

**Power over HDBaseT (PoH)** » PoH provides up to 100 watts of power to devices over HDBaseT technology and twisted pair cabling.

**Power Sum** » A test method for four-pair cable whereby the mathematical sum of pair-to-pair crosstalk from three pairs to one pair is measured.

**Premises** » Telephony term for the space occupied by a customer or authorized/joint user in a building(s) on continuous or contiguous property (except railroad rights of way, etc.) not separated by a public road or highway. Frequently used as "premises-based".

**Premises Wiring System** » The entire wiring system on the user's premises, especially the supporting wiring that connects the communications outlets to the network interface jack.

**Punchdown** » Refers to the use of an impact tool that enables installers to make efficient IDC style connections.

**RCDD®** (Registered Communications Distribution Designer) » The RCDD title is a professional credential granted by BICSI. RCDDs have demonstrated a superior level of knowledge of Information Transport Systems (ITS) design and associated disciplines.

**Return Loss (RL)** » A measure of the similarity of the impedance of a transmission line and the impedance at its terminations. It is a ratio, expressed in decibels, of the power of the outgoing signal to the power of the signal reflected back.

**RJ** (registered jack) » RJs are telephone and data jacks registered with the FCC. Specific RJs, such as RJ-11 and RJ-45, are widely used in the telecommunications industry. A much more accurate way to identify a jack is to specify the number of positions (width of opening) and number of conductors. Example: "8-position, 8-conductor (8P8C) jack" or "6-position, 4-conductor (6P4C) jack".

## Glossary

**RU (rack unit)** » A unit of measure of vertical space in an equipment rack or cabinet. One rack unit is equal to 45 mm (1.75 in).

**Standards** » Agreed-upon principles of performance. Standards are set by committees working under various trade and international organizations.

**Structured Cabling System** » A structured cabling system (SCS) is defined as the complete collective configuration of cabling and associated hardware that has been installed at a given site to provide a comprehensive telecommunications infrastructure.

**TDMM (Telecommunications Distribution Methods Manual)** » The TDMM is a publication from BICSI that is based on internationally accepted industry standards, codes and guidelines. The TDMM addresses the newest methodologies and recommends best practices for the design of structured cabling systems.

**TE (Telecommunications Enclosure)** » Also referred to as a zone enclosure, a TE is a housing for telecommunications equipment, cable terminations, cross-connect cabling, and wireless access points. A TE serves the function of an horizontal cross-connect (HC) for a portion of a building floor and provides access to the building's backbone and pathways. A TE should supplement, not replace, the requirement for a TR on a building floor.

**TIA (Telecommunications Industry Association)** » The TIA is a trade organization of manufacturers which sets standards for use of its member companies. Formerly fell under the umbrella of EIA. See [www.tiaonline.org](http://www.tiaonline.org).

**TO (telecommunications outlet)** » A connecting device in the work area on which horizontal cable terminates.

**TR (telecommunications room)** » A TR is an architectural space that provides an environmentally suitable and secure area for housing cables, terminations, cross-connects, hardware and telecommunications equipment.

**U/FTP** » Also classified as STP (shielded twisted pair), is twisted pair cable with individually foil-screened twisted pairs, but no overall shield.

**UL (Underwriters Laboratories®)** » A privately owned product safety certification organization. UL also certifies category-rated cable performance and quality.

**UTP (unshielded twisted pair)** » Also classified as U/UTP, is overall unshielded twisted pair with unshielded twisted pairs.

**Work Area (WA) or workstation** » A building space where occupants interact with telecommunications terminal equipment.

**WAN (wide area network)** » A computer network that covers a broad geographic area. WANs connect LANs and other networks together. Some are private, but many are built by Internet service providers, who provide connection from organizational LANs to the Internet.



## References

This guide has been developed consistent with all known applicable cabling practices as defined by the following:

### **ANSI/TIA-607-C**

Generic Telecommunications Bonding and Grounding (Earthing) for Customer Premises

### **ANSI/BICSI 002-2014**

Data Center Design and Implementation Best Practices

### **ANSI/TIA-568.0-D**

Generic Telecommunications Cabling for Customer Premises

### **ANSI/TIA-568.1-D**

Commercial Building Telecommunications Cabling Standard

### **ANSI/TIA-568.2-D**

Telecommunications Cabling, Copper Component, and Cabling Specifications

### **ANSI/TIA-569-D**

Commercial Building Standard for Telecommunications Pathways and Spaces

### **ANSI/TIA-606-C**

Administration Standard for Telecommunications Infrastructure of Commercial Buildings

### **ANSI/TIA-942-B**

Telecommunications Infrastructure Standard for Data Centers

### **BS EN 50174**

The European Standard for the Planning, Implementation and Operation of Information Technology Cabling Using Balanced Copper Cabling and Optical Fibre Cabling.

### **BS 6701**

British Standard: Telecommunications Equipment and Telecommunications Cabling Specification for Installation, Operation and Maintenance

### **BS 7671**

British Standard: Requirements for Electrical Installations. IET Wiring Regulations.

### **BS EN 50173**

Information Technology — Generic Cabling Systems

### **BS EN 50310**

Application of Equipotential Bonding and Earthing in Buildings with Information Technology Equipment

### **IEEE 802.3**

Ethernet-based LANs (Fast Ethernet, Gigabit Ethernet, 10 Gigabit Ethernet)

### **IEEE 1100**

Recommended Practice for Powering and Grounding Electronic Equipment

### **IEEE 1911.3**

Standard for HDBaseT™ 5Play

### **ISO/IEC 11801**

Generic Cabling for Customer Premises (multiple standards)

### **Telecommunications Distribution Methods Manual (TDMM)**

Published by BICSI

### **Underwriters Laboratories (UL)**

Applicable listings and ratings

**Always follow superseding national, provincial, country, and local codes and regulations.**

Today's networks must be fast and reliable, with the flexibility to handle ever-increasing data demands. Leviton can help expand your network possibilities and prepare you for the future. Our end-to-end cabling systems feature robust construction that reduces downtime, and performance that exceeds standards. We offer quick-ship make-to-order solutions from our US and UK factories. We even invent new products for customers when the product they need is not available. All of this adds up to the **highest return on infrastructure investment.**

**NETWORK SOLUTIONS DIVISION HEADQUARTERS**

2222 - 222nd Street S.E., Bothell, WA 98021 USA | [leviton.com/ns](http://leviton.com/ns)

**Inside Sales**  
 (800) 722 2082  
[insidesales@leviton.com](mailto:insidesales@leviton.com)

**International Inside Sales**  
 +1 (425) 486 2222  
[intl@leviton.com](mailto:intl@leviton.com)

**Technical Support**  
 (800) 824 3005 / +1 (425) 486 2222  
[appeng@leviton.com](mailto:appeng@leviton.com)

**NETWORK SOLUTIONS EUROPEAN HEADQUARTERS  
 (BRAND-REX LTD.)**

Viewfield Industrial Estate, Glenrothes, Fife KY6 2RS, UK  
[Leviton.com/NS/EMEA](http://Leviton.com/NS/EMEA)  
 Brand-Rex Limited is a subsidiary of Leviton Mfg. Co., Inc

**Customer Service**  
 +44 (0) 1592 772124  
[customerserviceeu@leviton.com](mailto:customerserviceeu@leviton.com)

**NETWORK SOLUTIONS MIDDLE EAST HEADQUARTERS**

Bay Square, Building 3, Office 205, Business Bay, Dubai - UAE  
[leviton.com/ns/middleeast](http://leviton.com/ns/middleeast)

**Customer Service**  
 +971 (4) 247 9800  
[lmeinfo@leviton.com](mailto:lmeinfo@leviton.com)

**CORPORATE HEADQUARTERS**

201 N. Service Road, Melville, NY 11747 USA  
[leviton.com](http://leviton.com)

**Customer Service**  
 (800) 323 8920 / +1 (631) 812 6000  
[customerservice@leviton.com](mailto:customerservice@leviton.com)

**ADDITIONAL OFFICES**

**Africa**  
 +971 (4) 247 9800  
[lmeinfo@leviton.com](mailto:lmeinfo@leviton.com)

**Asia / Pacific**  
 +1 (631) 812 6228  
[infoasean@leviton.com](mailto:infoasean@leviton.com)

**Canada**  
 +1 (514) 954 1840  
[pcservice@leviton.com](mailto:pcservice@leviton.com)

**Caribbean**  
 +1 (954) 593 1896  
[infocaribbean@leviton.com](mailto:infocaribbean@leviton.com)

**China**  
 +852 2774 9876  
[infochina@leviton.com](mailto:infochina@leviton.com)

**Colombia**  
 +57 (1) 743 6045  
[infocolombia@leviton.com](mailto:infocolombia@leviton.com)

**Latin America & Mexico**  
 +52 (55) 5082 1040  
[lsamarketing@leviton.com](mailto:lsamarketing@leviton.com)

**South Korea**  
 +82 (2) 3273 9963  
[infokorea@leviton.com](mailto:infokorea@leviton.com)

**ALL OTHER INTERNATIONAL INQUIRIES**

[international@leviton.com](mailto:international@leviton.com)